

DVD HOME THEATER SOUND SYSTEM

DVX-S120

(DVR-S120+NX-S120+NX-C120+NX-SW120)

DVD RECEIVER

DVR-S120

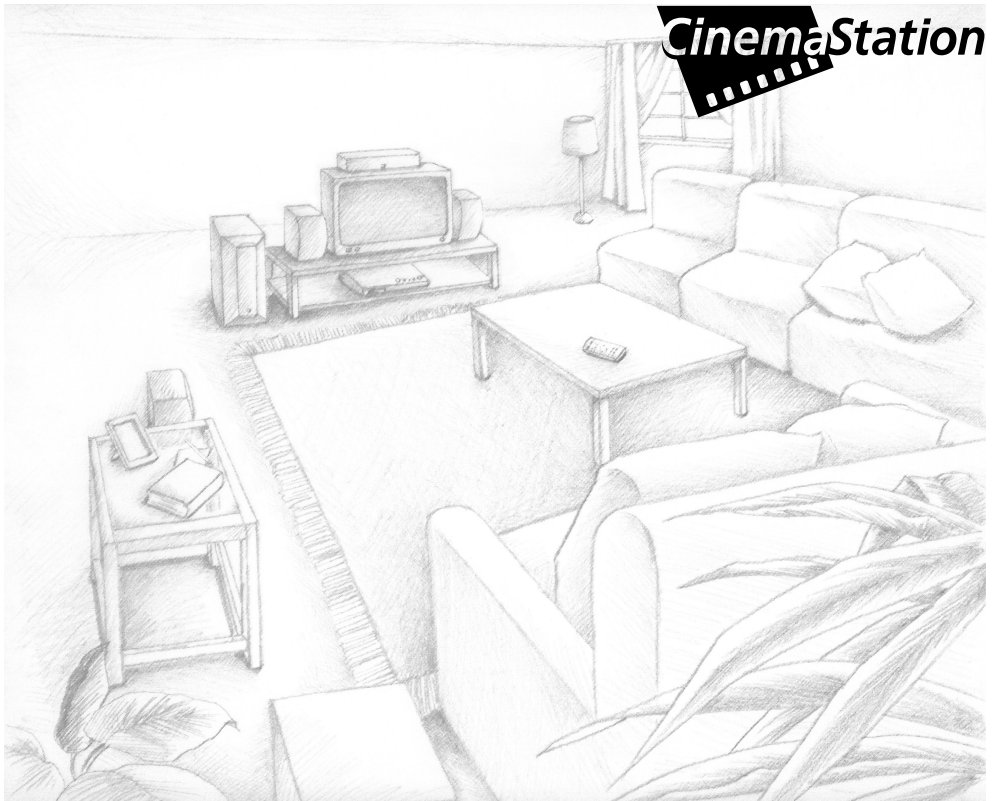

OWNER'S MANUAL

IMPORTANT SAFETY INSTRUCTIONS

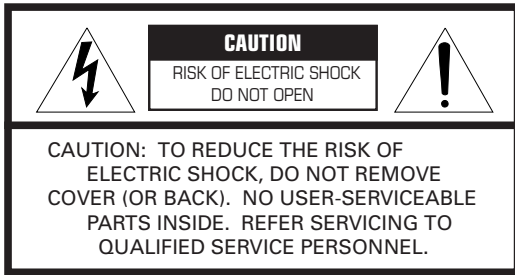

- Explanation of Graphical Symbols

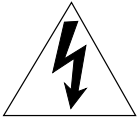

The lightning flash with arrowhead symbol, within an equilateral triangle, is intended to alert you to the presence of uninsulated “dangerous voltage” within the product’s enclosure that may be of sufficient magnitude to constitute a risk of electric shock to persons.



The exclamation point within an equilateral triangle is intended to alert you to the presence of important operating and maintenance (servicing) instructions in the literature accompanying the appliance.

IMPORTANT

Please record the serial number of this unit in the space below.

MODEL:

Serial No.:

The serial number is located on the rear or the bottom of this unit.

Retain this Owner’s Manual in a safe place for future reference.

- 1 Read these instructions.
- 2 Keep these instructions.
- 3 Heed all warnings.
- 4 Follow all instructions.
- 5 Do not use this apparatus near water.
- 6 Clean only with dry cloth.
- 7 Do not block any ventilation openings. Install in accordance with the manufacturer’s instructions.
- 8 Do not install near any heat sources such as radiators, heat registers, stoves, or other apparatus (including amplifiers) that produce heat.
- 9 Do not defeat the safety purpose of the polarized or grounding-type plug. A polarized plug has two blades with one wider than the other. A grounding type plug has two blades and a third grounding prong. The wide blade or the third prong are provided for your safety. If the provided plug does not fit into your outlet, consult an electrician for replacement of the obsolete outlet.
- 10 Protect the power cord from being walked on or pinched particularly at plugs, convenience receptacles, and the point where they exit from the apparatus.
- 11 Only use attachments/accessories specified by the manufacturer.
- 12 Use only with the cart, stand, tripod, bracket, or table specified by the manufacturer, or sold with the apparatus. When a cart is used, use caution when moving the cart/apparatus combination to avoid injury from tip-over. 
- 13 Unplug this apparatus during lightning storms or when unused for long periods of time.
- 14 Refer all servicing to qualified service personnel. Servicing is required when the apparatus has been damaged in any way, such as power-supply cord or plug is damaged, liquid has been spilled or objects have fallen into the apparatus, the apparatus has been exposed to rain or moisture, does not operate normally, or has been dropped.
- 15 Be sure to allow spaces of at least 20 cm above, 10 cm behind and on both sides the unit.
- 16 Do not place the following objects on this unit:
A vessel with water in it.
If the vessel falls by vibrations and water spills, it may cause damage to the unit, and/or you may get an electric shock.

FCC INFORMATION (for US customers)

1. IMPORTANT NOTICE : DO NOT MODIFY THIS UNIT!

This product, when installed as indicated in the instructions contained in this manual, meets FCC requirements. Modifications not expressly approved by Yamaha may void your authority, granted by the FCC, to use the product.

2. IMPORTANT :

When connecting this product to accessories and/or another product use only high quality shielded cables. Cable/s supplied with this product MUST be used. Follow all installation instructions. Failure to follow instructions could void your FCC authorization to use this product in the USA.

3. NOTE :

This product has been tested and found to comply with the requirements listed in FCC Regulations, Part 15 for Class "B" digital devices. Compliance with these requirements provides a reasonable level of assurance that your use of this product in a residential environment will not result in harmful interference with other electronic devices.

This equipment generates/uses radio frequencies and, if not installed and used according to the instructions found in the users manual, may cause interference harmful to the operation of other electronic devices.

Compliance with FCC regulations does not guarantee that interference will not occur in all installations. If this product is found to be the source of interference, which can be determined by turning the unit "OFF" and "ON", please try to eliminate the problem by using one of the following measures:

Relocate either this product or the device that is being affected by the interference.

Utilize power outlets that are on different branch (circuit breaker or fuse) circuits or install AC line filter/s.

In the case of radio or TV interference, relocate/reorient the antenna. If the antenna lead-in is 300 ohm ribbon lead, change the lead-in to coaxial type cable.

If these corrective measures do not produce satisfactory results, please contact the local retailer authorized to distribute this type of product. If you can not locate the appropriate retailer, please contact Yamaha Electronics Corp., U.S.A. 6660 Orangethorpe Ave, Buena Park, CA 90620.

The above statements apply ONLY to those products distributed by Yamaha Corporation of America or its subsidiaries.

We Want You Listening For A Lifetime

YAMAHA and the Electronic Industries Association's Consumer Electronics Group want you to get the most out of your equipment by playing it at a safe level. One that lets the sound come through loud and clear without annoying blaring or distortion – and, most importantly, without affecting your sensitive hearing.

Since hearing damage from loud sounds is often undetectable until it is too late, YAMAHA and the Electronic Industries Association's Consumer Electronics Group recommend you to avoid prolonged exposure from excessive volume levels.



CAUTION: READ THIS BEFORE OPERATING YOUR UNIT.

- 1 To assure the finest performance, please read this manual carefully. Keep it in a safe place for future reference.
- 2 Install this sound system in a well ventilated, cool, dry, clean place with at least 10 cm on the top, 10 cm on the left and right, and 10 cm at the back of DVR-S120, and 20 cm on the top, 20 cm on the left and right, and 20 cm at the back of NX-SW120 — away from direct sunlight, heat sources, vibration, dust, moisture, and/or cold.
- 3 Locate this unit away from other electrical appliances, motors, or transformers to avoid humming sounds.
- 4 Do not expose this unit to sudden temperature changes from cold to hot, and do not locate this unit in a environment with high humidity (i.e. a room with a humidifier) to prevent condensation inside this unit, which may cause an electrical shock, fire, damage to this unit, and/or personal injury.
- 5 Avoid installing this unit where foreign object may fall onto this unit and/or this unit may be exposed to liquid dripping or splashing. On the top of this unit, do not place:
 - Other components, as they may cause damage and/or discoloration on the surface of this unit.
 - Burning objects (i.e. candles), as they may cause fire, damage to this unit, and/or personal injury.
 - Containers with liquid in them, as they may fall and liquid may cause electrical shock to the user and/or damage to this unit.
- 6 Do not cover this unit with a newspaper, tablecloth, curtain, etc. in order not to obstruct heat radiation. If the temperature inside this unit rises, it may cause fire, damage to this unit, and/or personal injury.
- 7 Do not plug in this unit to a wall outlet until all connections are complete.
- 8 Do not operate this unit upside-down. It may overheat, possibly causing damage.
- 9 Do not use force on switches, knobs and/or cords.
- 10 When disconnecting the power cord from the wall outlet, grasp the plug; do not pull the cord.
- 11 Do not clean this unit with chemical solvents; this might damage the finish. Use a clean, dry cloth.
- 12 Only voltage specified on this unit must be used. Using this unit with a higher voltage than specified is dangerous and may cause fire, damage to this unit, and/or personal injury. YAMAHA will not be held responsible for any damage resulting from use of this unit with a voltage other than specified.
- 13 To prevent damage by lightning, disconnect the power cord from the wall outlet during an electrical storm.
- 14 Do not attempt to modify or fix this unit. Contact qualified YAMAHA service personnel when any service is needed. The cabinet should never be opened for any reasons.
- 15 When not planning to use this unit for long periods of time (i.e. vacation), disconnect the AC power plug from the wall outlet.
- 16 Be sure to read the “Solutions to Common Problems” section on common operating errors before concluding that this unit is faulty.
- 17 Before moving this unit, press STANDBY/ON to set this unit in standby mode, and disconnect the AC power plug from the wall outlet.
- 18 Do not place much pressure against the Subwoofer net. It may break the net or the unit may fall, resulting in injury.
- 19 Do not place anything fragile beside the Subwoofer, as air pressure is produced that may break it, result in malfunction or cause injury.
- 20 Condensation will form when the surrounding temperature changes suddenly. Disconnect the power cord from the outlet, then leave the unit alone.
- 21 When using the unit for a long time, the unit may become warm. Turn the power off, then leave the unit alone for cooling.

DVR-S120

This unit is not disconnected from the AC power source as long as it is connected to the wall outlet, even if this unit itself is turned off. This state is called the standby mode. In this state, this unit is designed to consume a very small quantity of power.

FOR CANADIAN CUSTOMERS

To prevent electric shock, match wide blade of plug to wide slot and fully insert.

This Class B digital apparatus complies with Canadian ICES-003.

DANGER

When this unit is plugged to the wall outlet, do not place your eyes close to the opening of the disc tray and other openings to look into inside.

The laser component in this product is capable of emitting radiation exceeding the limit for Class 1.

DVR-S120

The name plate is located on the bottom of the unit.

WARNING

TO REDUCE THE RISK OF FIRE OR ELECTRIC SHOCK, DO NOT EXPOSE THIS APPLIANCE TO RAIN OR MOISTURE.

■ For U.K. customers

If the socket outlets in the home are not suitable for the plug supplied with this appliance, it should be cut off and an appropriate 3 pin plug fitted. For details, refer to the instructions described below.

Note

- The plug severed from the mains lead must be destroyed, as a plug with bared flexible cord is hazardous if engaged in a live socket outlet.

■ Special Instructions for U.K. Model

IMPORTANT

THE WIRES IN MAINS LEAD ARE COLOURED IN ACCORDANCE WITH THE FOLLOWING CODE:

Blue: NEUTRAL

Brown: LIVE

As the colours of the wires in the mains lead of this apparatus may not correspond with the coloured markings identifying the terminals in your plug, proceed as follows:

The wire which is coloured BLUE must be connected to the terminal which is marked with the letter N or coloured BLACK. The wire which is coloured BROWN must be connected to the terminal which is marked with the letter L or coloured RED. Making sure that neither core is connected to the earth terminal of the three pin plug.

III CAUTION

CAUTION

Use of controls or adjustments or performance of procedures other than those specified herein may result in hazardous radiation exposure.

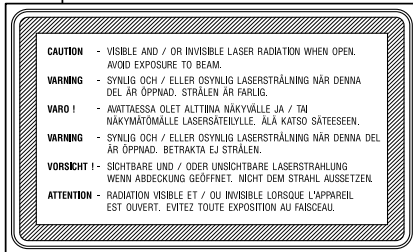
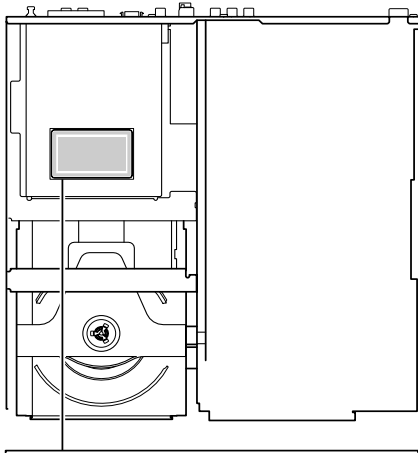

● The name plate is located on the bottom of the unit.

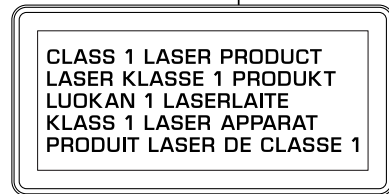
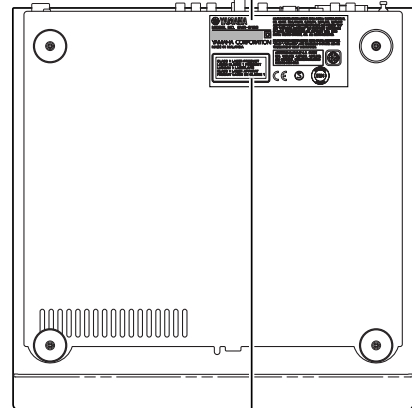
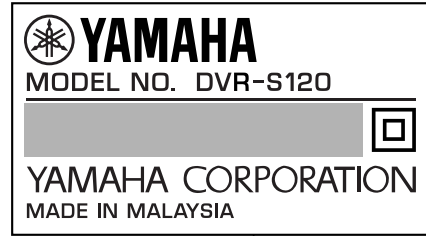

This product is a DVD home theater sound system consisting of the components shown on the table.

Please check to make sure that all of the components listed in the table are included.

Model name	Category	No. of pcs
DVR-S120	DVD receiver	1
NX-S120	Satellite Speaker (for front/surround)	4
NX-C120	Center speaker	1
NX-SW120	Subwoofer	1

NX-SW120

VOLTAGE SELECTOR

(Korea, Asia and General models only)

The VOLTAGE SELECTOR on the

rear panel of this unit must be set

for your local main voltage

BEFORE plugging into the AC

main supply.

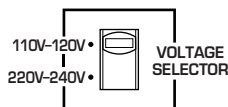

In a few steps, a whole new world of DVD will open up.

Settle into your favorite place
on the sofa and let the show begin.

LET'S GET THINGS READY!

➔Page 6, "Preparation"

Decide on a place for the speakers, perform a few simple connections, and that's all there is to it.

- Connecting Speakers and TV to CinemaStation couldn't be easier.
- Connecting the Speaker Cables with one touch colored connectors.

Come on, let's watch a DVD!

➔Page 10, "Basic Operations"

Transform your room into a home theater in 3 steps.

- Connect Speakers and TV
- ▼
- Play a disc
- ▼
- Select a sound field

- Sound fields to match the movie you are viewing and experience the feeling of being there.
- Progressive scan technology for enjoying high-quality video even on a large screen.

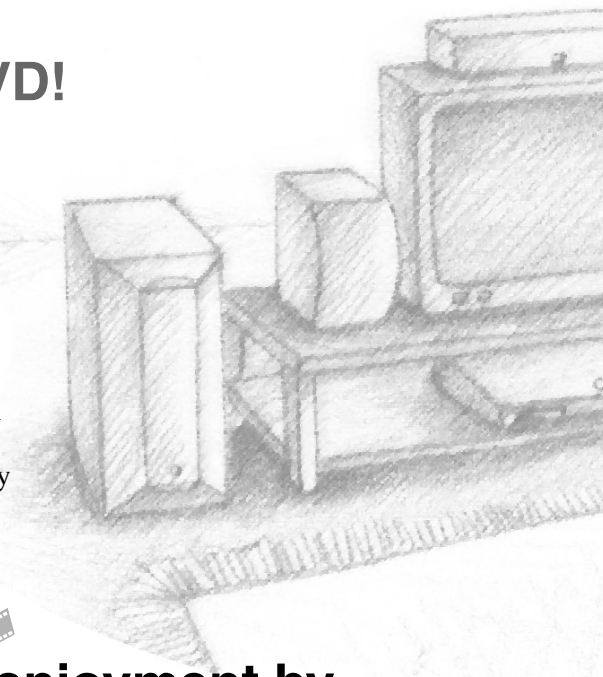

Double and triple your enjoyment by CONNECTING OTHER EQUIPMENT.

➔Page 46, "Using Other Equipment"

- Enhance the feeling of movement with DSP Programs when you play video games.
- Listen to and record CD-R and MiniDisc media.
- View and dub video media.

Enjoy playing **A VARIETY OF DISCS!**

➔Page 28, “Playing Video and Music Discs”

In 3 short steps, play everything from commercial CDs to your own homemade discs.

- Connect Speakers ▼
- Play a disc ▼
- Select a sound field

- Enjoy playing all types of discs including audio and video CDs and MP3 music recorded on CD-Rs.
- Create the sound and ambience to match the music you are listening to, whether it be the excitement of a nightclub or the acoustics of a concert hall.



Let's listen to an **FM/AM BROADCAST!**

➔Page 38, “Listening to the Radio”

In 2 quick steps you can enjoy live radio broadcasts.

- Connect Speakers and Antennas ▼
- Select a channel

- In addition to Auto Tuning, you can use various controls including Auto Preset for FM channels.

It's time to **TAKE YOUR LISTENING EXPERIENCE UP A NOTCH!**

➔Page 53, “Creating the Best Listening Space”

- With the Speakers you can create a sound space to match the listening environment of the room.
- The Matrix 6.1 Decoder provides virtual surround back speakers for experiencing a remarkable acoustic presence.
- SILENT CINEMA provides an incredible listening presence with headphones.

CONTENTS

Basic

Playing back a DVD

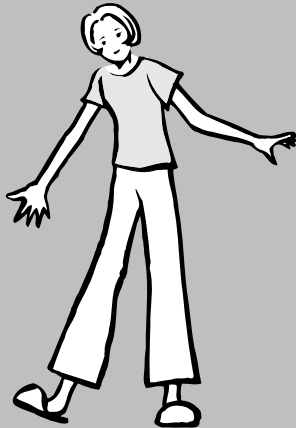

Preparation

- Introduction Page 6
 - About this Manual Page 6
- Supplied Accessories Page 6
- Preparing the Remote Control Page 7
- Preparing the Speakers Page 7
 - Placing the Speakers Page 7
- Connecting the Speakers and TV Page 8

Basic Operations

- Viewing a DVD Page 10
- Useful Features Page 13
 - Selecting the Audio Language Page 13
 - Selecting the Subtitle Language Page 13
 - Moving Forward and Backward Page 13
 - Adjusting the Audio Volume Page 13
 - Pausing Playback Page 13
 - Switching the Viewing Angle Page 14
 - Restarting Playback from the Stop Position (Memory Resume) Page 14
 - Enhancing the Sound Presence Page 15
 - Turning off the Sound Page 15
 - Controlling the DVDs Your Children Can View Page 15
 - Enhancing Video Quality Page 15
 - Answers to Common Problems Page 15

Sound Presence

- Finding the Best DSP Effect Page 16

Advanced



Advanced Features

- Names and Functions of Parts Page 18
 - Top and Front Page 18
 - CinemaStation Display Page 20
- Remote Control Features Page 21
 - Amp Mode Button Names and Functions Page 22
 - DVD/CD Mode Button Names and Functions Page 23
- Using the On Screen Menu Page 24

Selecting the Media Device

- Selecting the Equipment Page 26

Playing Video and Music Discs

- Playback Methods Page 28
 - Selecting a Scene or Tune Page 28
 - Customizing Playback Order (Program Play) Page 31
 - Repeating a Disc or Track (Repeat Play) Page 34
 - Using a Disc Menu Page 36
 - MP3 Playback Features Page 37

Listening to the Radio

- Connecting the Antennas Page 38
 - Connecting the FM Antenna Page 38
 - Connecting the AM Loop Antenna Page 38
- Listening to the Radio Page 39
 - Selecting the Radio Tuner Page 39
 - Selecting Radio Stations Page 39
 - Setting Channels in Advance (Preset) Page 41
 - Selecting a Preset Station (Preset Tuning) Page 43
 - Changing the Order of Preset Stations Page 43
 - Receiving RDS Stations
 - (U.K. and Europe models only) Page 44

Using Other Equipment

- Connecting Video Equipment Page 46
 - Connecting a Game Console or VCR Page 46
 - Operating a VCR Page 48
 - Playing a Video Game or Operating a Video Camera Page 48
 - Dubbing from a Video Camera to a VCR Page 49
- Connecting Audio Equipment Page 50
 - Connecting a CD or MD Recorder Page 50
 - Recording Audio from CinemaStation Page 52

Creating the Best Listening Space

- Placing the Speakers (NX-P120) Page 53
 - Placing the Center Speaker Page 53
 - Placing the Subwoofer Page 53
 - Placing the Front and Surround Speakers Page 54
 - Using Commercially Available Speakers or Cables Page 56
- Adjusting the Speaker Volume Level Page 58
 - Adjusting the Speaker Balance with a Test Tone Page 58
 - Adjusting the Speaker Volume Level During Playback Page 60
- Setting the Speaker Size Page 62
 - Setting the Speaker Mode Page 62

More Information about DSP (Surround) Effects

- Selecting DSP Program Effects Page 64
 - Using Matrix 6.1 Page 64
 - Using All Speakers for CD or Video playback Page 66
 - Using Front Speakers Only for DSP Program (Virtual Cinema DSP) Page 68
 - Using a DSP Program with Headphones (SILENT CINEMA) Page 69
 - Using a DSP Program with Low Volume (Night Listening) Page 70
 - Changing the Delay Time of a DSP Program Page 71
 - Reproducing the Original Dolby and DTS Sound Page 73
 - Reproducing Stereo Sound Page 74

Types of Input Signals

- Types of Input Signals Page 75
 - Checking Sound Information (Input Signal Information Display) Page 75
 - Switching Input Modes Page 77

Additional Features

- Using the Sleep Timer Page 78
- Enjoying High-Quality Video Page 79
- Protecting Your Children
 - from Undesirable Scene Page 80
 - Setting the Password and Parental Control Level Page 80
 - Locking a Disc Page 82

Operating Other Equipment with the CinemaStation Remote Control

- Storing Manufacturer Codes in the Remote Control Page 83
 - Setting the Manufacturer Code Page 83
 - Available Operations Page 84
 - Manufacturer Code List Page 86

Using the SET MENU

- Using the SET MENU Page 88
 - SET MENU List Page 88
 - Navigating the SET MENU Page 89

Using the On Screen Menu

- Using the On Screen Menu Page 92
 - Navigating the On Screen Menu Page 92
 - On Screen Menu Guide Page 94

Appendix

- Solutions to Common Problems Page 96
 - General Problems Page 96
 - Disc Playback Page 99
 - Radio Reception Page 100
 - Remote Control Page 101
- Information Page 102
- Glossary Page 105
- Index Page 107
- Specifications Page 109

Introduction

Your DVD Home Theater Sound System DVX-S120 consists of the following components.

DVD Receiver (DVR-S120) 1 unit	
Speaker Set (NX-P120)	Satellite Speakers (Front, Surround) (NX-S120) 4 units Center Speaker (NX-C120) 1 unit Subwoofer (NX-SW120) 1 unit

Explanations in this Owner's Manual are based on DVX-S120 (DVD Receiver (DVR-S120) and Speaker Set (NX-P120)). If you use speakers other than NX-P120, make sure to set the speaker size and volume level in advance.

→Page 62, "Setting the Speaker Size"

→Page 58, "Adjusting the Speaker Volume Level"

About this Manual

- **Advice** explains additional operating tips that you may find useful.
- **Please...** indicates an operation that you should definitely perform.
- In this manual, operations that can be performed on either the DVD Receiver or Remote Control are explained using the Remote Control.
- In this manual, Remote Control descriptions and illustrations are based on models other than those in the U.K. or Europe. Any exceptions are clearly stated.
- This Owner's Manual was printed before final product development. After printing, some product specifications may change due to operational upgrades and other reasons. In this case, the specifications of the product itself will take precedence over the specifications in this manual.
- In some cases, graphics or terms used may differ slightly from the actual product or packaging to facilitate explanation.

Supplied Accessories

Make sure all of the following accessories are in the box.

DVR-S120

Remote Control

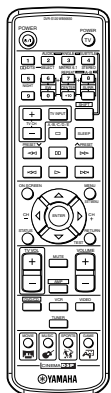

Batteries (2)
(AA, R06, UM-3)

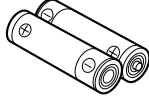

AM Loop Antenna

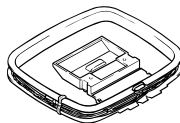

Indoor FM Antenna



Video Pin Cable

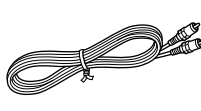

Speaker Cables (Surround: 15 m (2),
Front, Center: 5 m (3))

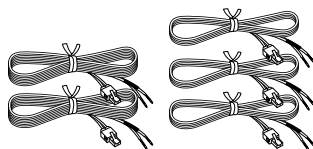

NX-P120: NX-S120, NX-C120, NX-SW120

Subwoofer Cable
(1 pin, 5 m, (1))

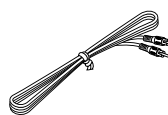

Mounting Brackets (Front,
Surround Speakers (4))

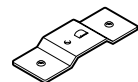

System Control Cable
(5 m (1))

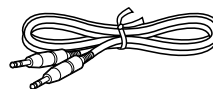

Screws (M4 × 10) (Front,
Surround Speakers (4))



Fasteners (Center (2))



Non-Skid Pads
(Subwoofer, 1 Set (4))

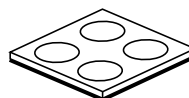

Non-Skid Pads (Front, Surround
Speakers, 2 Sets (16))

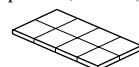

Preparing the Remote Control

Put the batteries in the Remote Control.

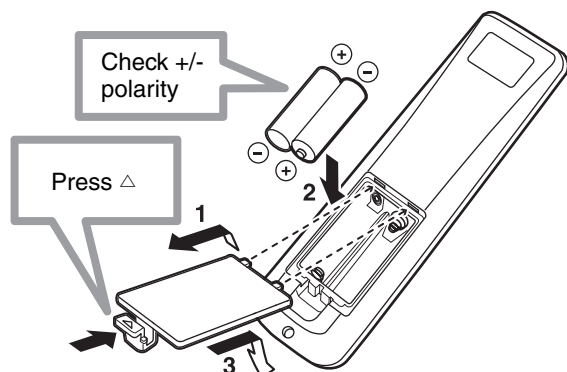

- 1 Press the Δ mark and slide off the back cover.
- 2 Insert the two supplied batteries (AA, R06, UM-3) into the battery compartment.
- 3 Close the back cover.

Preparing the Speakers

The Front Speakers, Surround Speakers, Center Speaker and Subwoofer have special roles based on the type of sound each produces.

- The Front Speakers produce front channel sound (stereo) and sound effects.
- The Surround Speakers produce surround sound and sound effects.
- The Center Speaker produces sound oriented toward the center of the screen such as dialog or vocals.
- The Subwoofer produces bass sounds and the LFE signal contained in Dolby Digital and DTS.

Placing the Speakers

Place the speakers as shown in the diagram below.

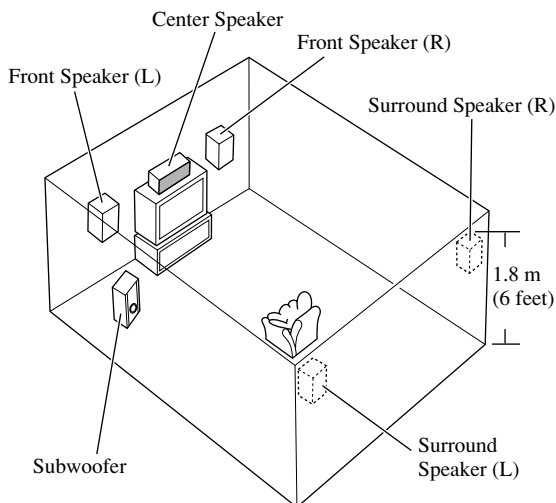

Front Speakers (L, R)

Place the Front Left and Right Speakers an equal distance from the ideal listening position. The distance of each speaker from each side of the video monitor should be the same.

Center Speaker

Align the front face of the center speaker with the front face of your video monitor. Place the speaker as close to the monitor as possible (such as directly over or under the monitor) and centrally between the front speakers.

Surround Speakers (L, R)

Place these speakers behind your listening position, facing slightly inwards, approximately 1.8 m (6 feet) above the floor.

Subwoofer

The position of the Subwoofer is not so critical, because low bass sounds are not highly directional. But it is better to place the Subwoofer near the Front Speakers. Turn it slightly toward the center of the room to reduce wall reflections.

Advice

- You can secure the Center Speaker, Surround Speakers or Subwoofer in place using fasteners or non-skid pads. You can hang the Front and Surround Speakers from the wall or attach them to optional speaker stands.
See page 53, "Placing the Speakers (NX-P120)".

Note

- If the television (monitor) image is distorted, place the speakers away from the television.

Connecting the Speakers and TV

Please ... Connect the power cord after connecting the speakers and TV.

Connect the cable core with the color band near the tip to the + connector. Be careful, if you reverse the cables, the sound will be unnatural.

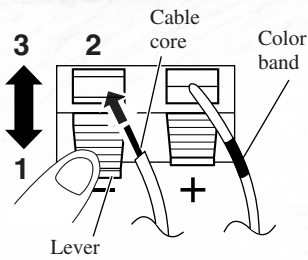

- 1 Press the lever down.
- 2 Insert the speaker cable core into the hole.
- 3 Release the lever and the lever will snap back into place.

Front Right Speaker

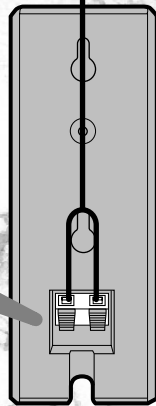

Speaker Cable (Red)

Connect the plug to the jack of the same color. Insert it firmly.
 Red, green, white: Face the tab upwards and insert.
 Gray, blue: Face the tab downwards and insert.

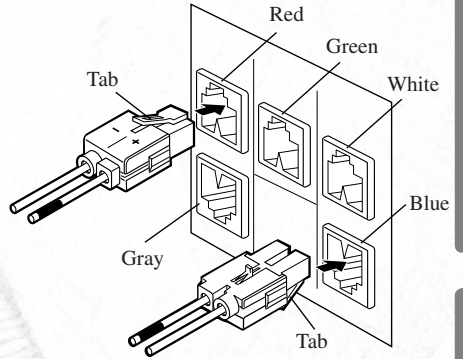

Speaker Cable (Gray)

Surround Right Speaker

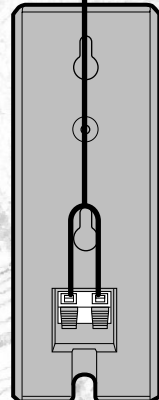

Please ...

- Do not allow the speaker cable cores to touch each other.
- Do not use excessive force when inserting plugs, connectors or jacks as they can be damaged.

CinemaStation

Preparation

TV

Front Left Speaker

Center Speaker

Speaker Cable (Green)

Speaker Cable (White)

Connect the power cord after making all other connections.

Connect to the S-video or Y/Pb/Pr jack on the TV.

Turn off the TV before connecting.

VIDEO IN

VIDEO

Video Pin Cable

DVD Receiver

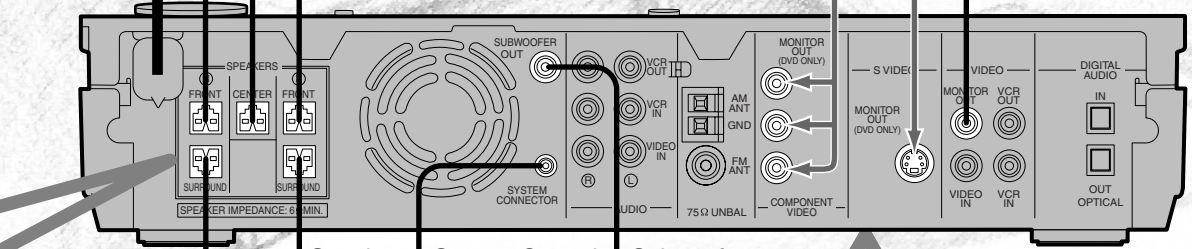

Speaker Cable (Blue)

System Control Cable

Subwoofer Cable

Surround Left Speaker

Subwoofer

Connect the power cord after making all other connections.

AV MONITOR OUT (DVD ONLY)
 (U. K. and Europe models only)
 If your monitor has only one jack for video input, you can use CinemaStation's SCART output jack for connecting directly to the monitor. This connection provides the best picture quality. See page 95 when the screen does not appear properly.



Connecting with S-video

Use a commercially available S-video cable to connect the S VIDEO MONITOR OUTPUT to your TV's S-video input.

English

Viewing a DVD

It's time to play a DVD. Select a disc and begin from step 1.

1

Turn on the TV.

Use the TV remote control or power switch.

2

Switch TV Input.

Use the TV remote control or the input switch button on the television.
For example, switch to video input 1 if CinemaStation is connected to video input 1.

3

Press POWER.

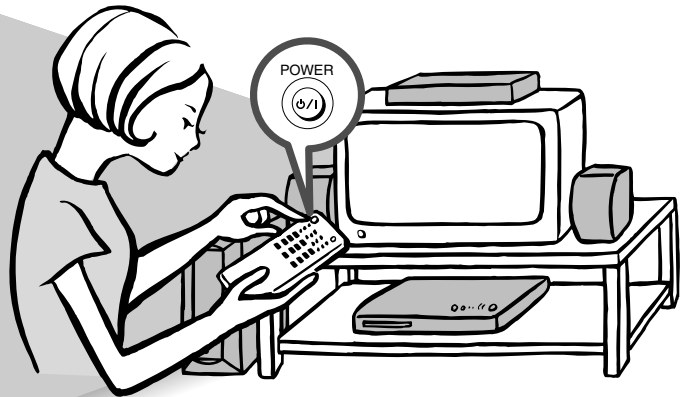
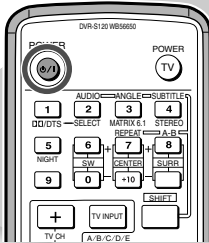

CinemaStation turns on.
The CinemaStation Display lights up.

4

Press on the CinemaStation.

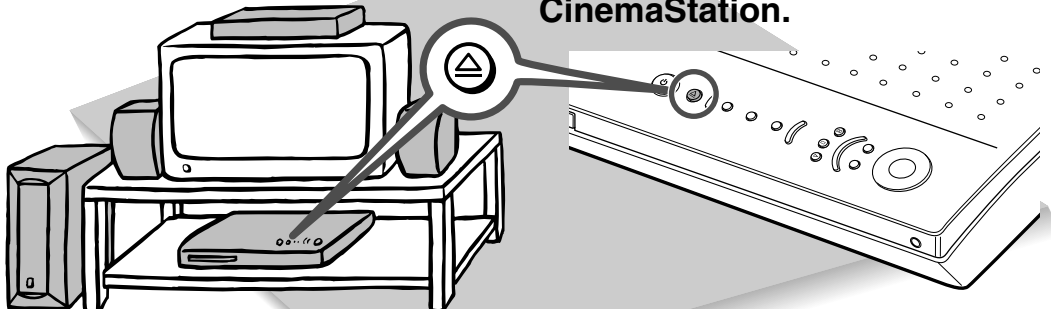

The disc tray slides out.

5

Place a disc in the tray.**Please ...**

- Place the disc with the label side facing up.
- Hold the disc by its edge and hole in the center to avoid touching the surface of the disc.

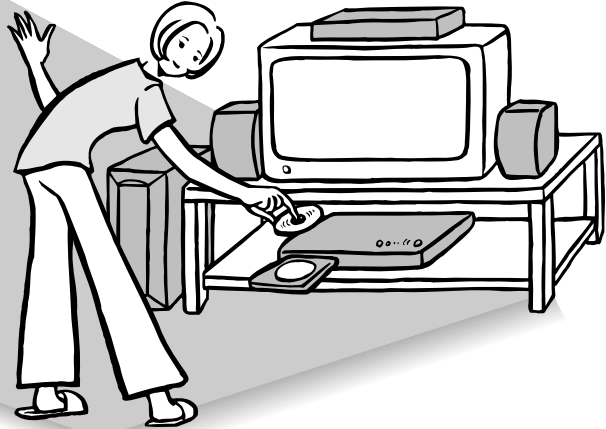

6

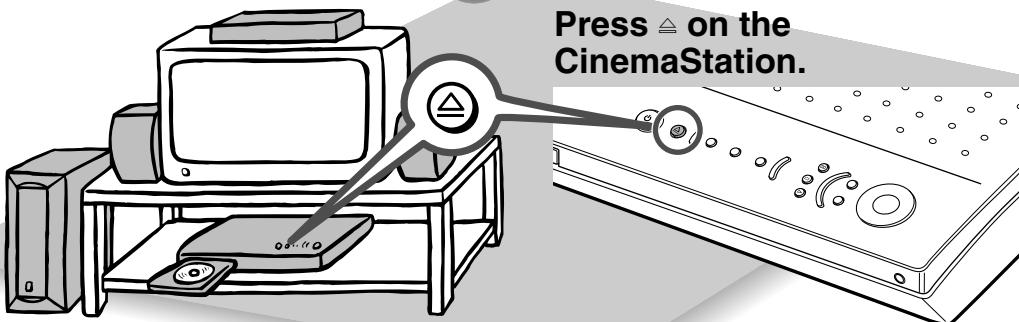
Press \triangle on the CinemaStation.

The disc tray slides in.

7

Press DVD/CD.

CinemaStation enters DVD/CD mode.

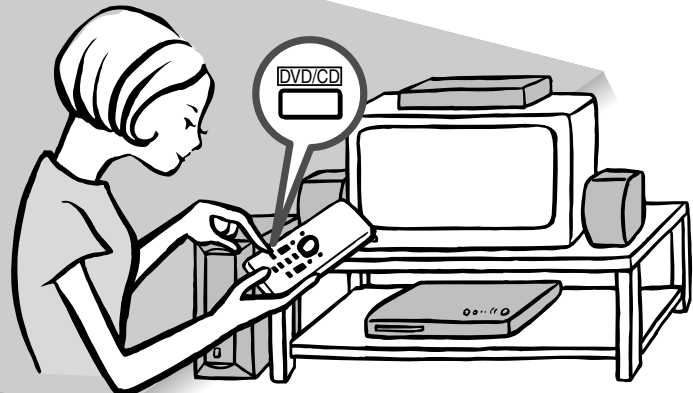

8

Press .

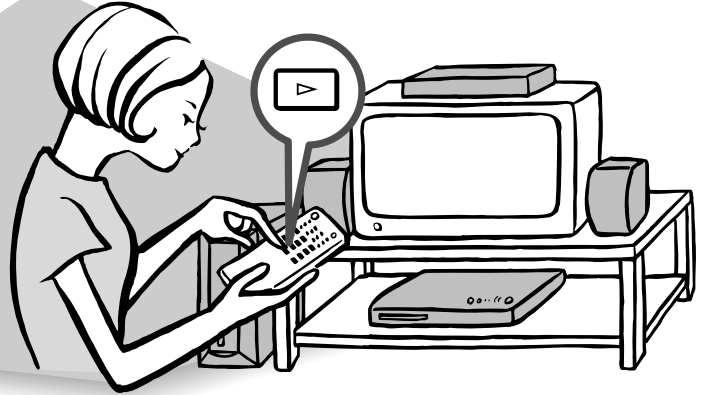
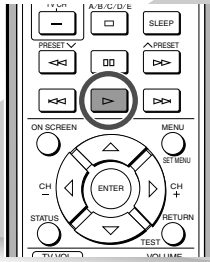

The DVD starts playing.

9

Press  to stop playback.

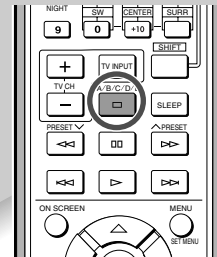
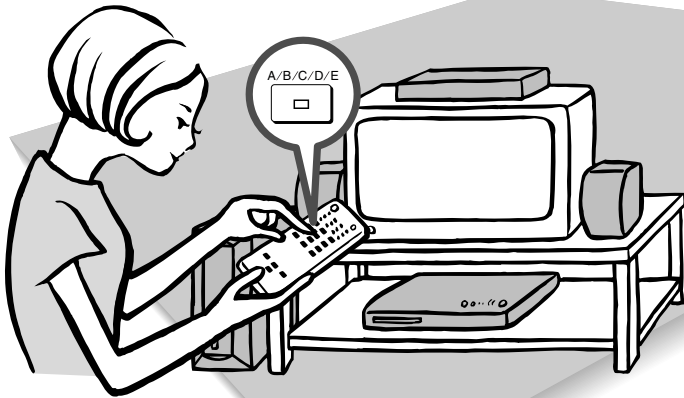

To change discs

Press  on CinemaStation to eject the disc.



Set another disc in the tray and press .

10

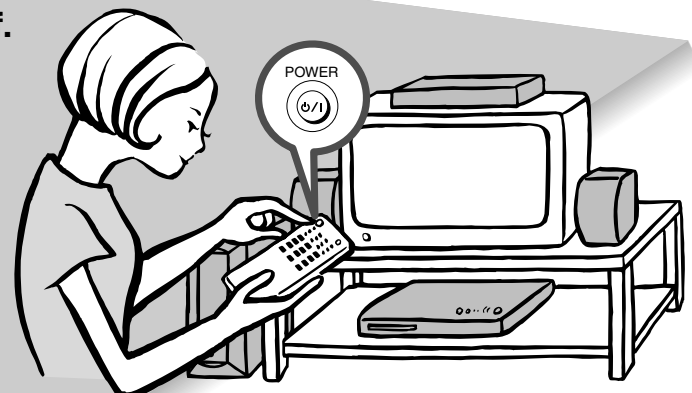
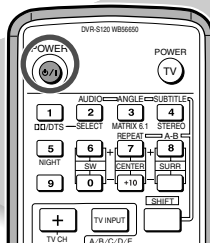
Press **POWER** to turn off.



Eject the disc before turning off the power.

After finished playing, press  on CinemaStation to eject the disc. Then press  once more to close the disc tray.

Useful Features

Selecting the Audio Language

- 1 While holding down SHIFT, press AUDIO.
- 2 While viewing the TV screen, press Δ or ∇ to select the audio language you want.
The audio language changes each time you press AUDIO while holding down SHIFT.

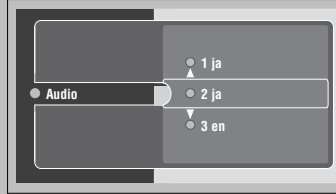

This selection is available when the DVD disc contains multi-language audio.

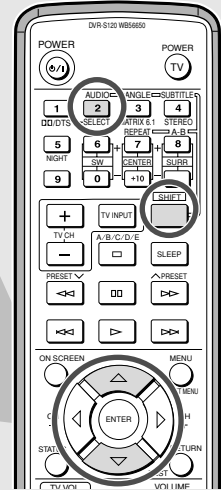

Basic Operations

Selecting the Subtitle Language

- 1 While holding down SHIFT, press SUBTITLE.
- 2 While viewing the TV screen, press Δ or ∇ to select the subtitle language you want. Select "None" to turn off the subtitle.
The subtitle language changes each time you press SUBTITLE while holding down SHIFT.

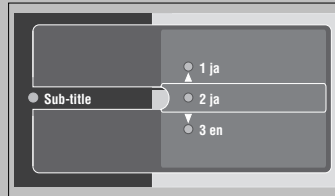

This selection is available when the DVD disc contains multi-language subtitles.

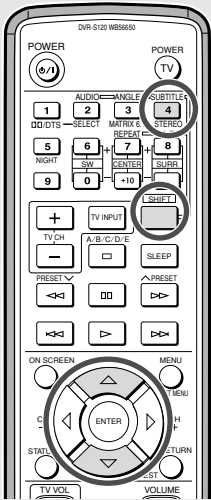

Moving Forward and Backward

- To fast reverse: Press \lll .
- To fast forward: Press \ggg .
- To move to the start of the currently playing or previous chapter: Press \lll .
- To move to the start of the next chapter: Press \ggg .



Adjusting the Audio Volume

Press + to increase the volume and - to decrease.

Pausing Playback

Press \square .
To resume playback press \triangleright .

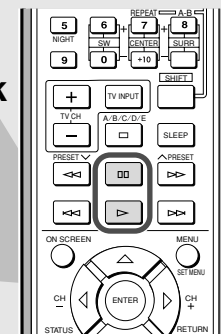
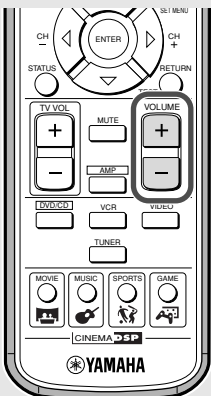

English

Useful Features

Switching the Viewing Angle

While holding down SHIFT, press ANGLE.

The video angle changes each time you press ANGLE while holding down SHIFT.

Advice

- You can change the angle with \triangle , ∇ , or Number buttons, instead of ANGLE.

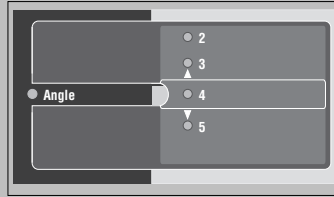

This selection is available when the DVD disc contains multi-angle content.

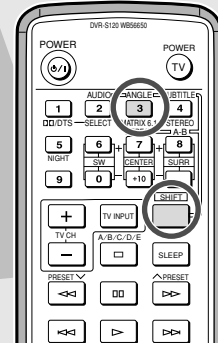

Restarting Playback from the Stop Position (Memory Resume)

Pressing \square during playback enables Memory Resume. CinemaStation memorizes the stop position. Pressing \triangleright starts playing back the disc from the stop position.

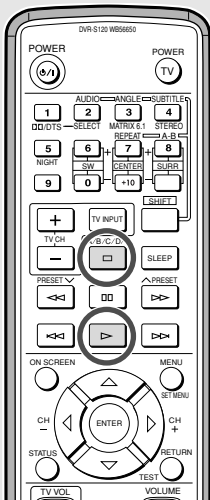

Useful Features

Enhancing the Sound Presence

CinemaStation is loaded with a variety of DSP Programs, so you can experience from the raw excitement of a rock concert to the breathtaking space of a cinemagraphic spectacle.
See page 64, "More Information about DSP (Surround) Effects".

Turning off the Sound

Press MUTE on the Remote Control.
Press it again to turn on the sound.

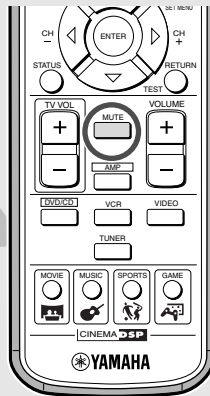

Controlling the DVDs Your Children Can View

You can set the Parental Control level and lock discs.
See page 80, "Protecting Your Children from Undesirable Scene".

Enhancing Video Quality

CinemaStation can use progressive image playback to render the full beauty of DVD video.
You can connect a television that has component video input jacks to CinemaStation's COMPONENT VIDEO jacks and enjoy progressive scan imaging.
See page 79, "Enjoying High-Quality Video".

Answers to Common Problems

I cannot change the audio or subtitle language

The disc may have only one audio and one subtitle language.

No subtitles appear

Check the disc jacket to make sure subtitles are available.

I followed each step correctly but the disc doesn't play.

Some discs have a Disc Menu or DVD Menu.
Your settings may change if you use this type of menu.

Finding the Best DSP Effect

Changing the DSP effect based on listening and viewing content

Select a DSP Program for the movie or music and experience the sound of a movie theater or concert hall. Follow the chart below to select the DSP Program that offers the acoustic qualities you want.

Advice

- Experiment with different sound field effects until you find the DSP Program that you feel best matches your source.
- CinemaStation has other DSP Programs not listed below. See page 64, “**Selecting DSP Program Effects**”.

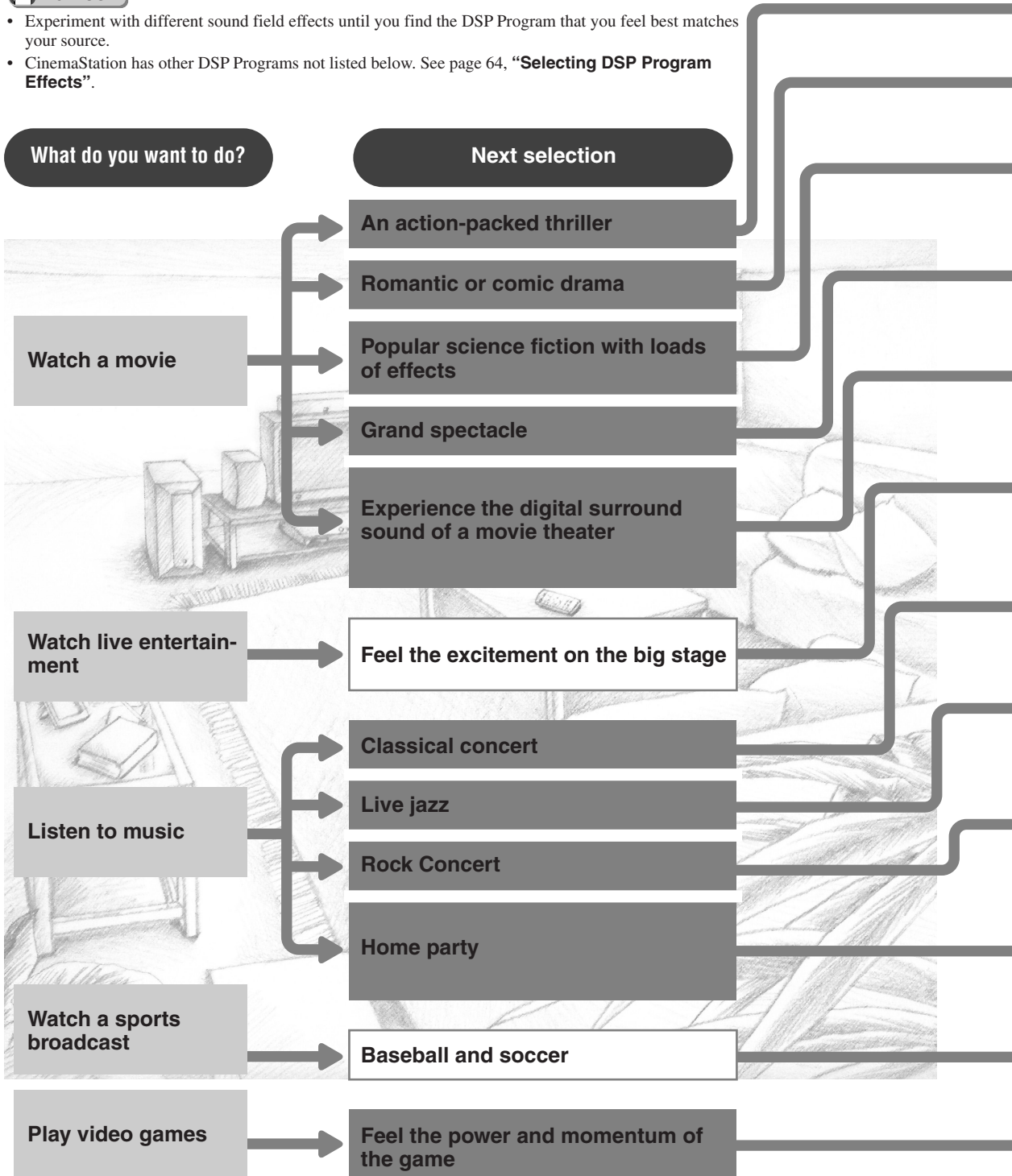

Finding the right DSP Program

Selecting a DSP Program

- Action**
Enhances the stereoscopic effect for a thrilling sense of presence only found in an action movie.
- Drama**
Expresses surround sounds softly so that voice and dialog are clear and crisp.
- Sci-Fi (Science Fiction)**
Fills the space with music and sound that have an eerie sense of reality. Suitable for serious science fiction that has a good story line.
- Spectacle**
Expresses super-wide spaces. Suitable for movies that have a powerful visual impact.
- Theater**
Preserves the power of Dolby or DTS Surround for experiencing the rich acoustical presence of a movie theater.



- Music Video**
Magnifies the feeling of listening to live rock or jazz in a concert hall. The screen image and sound field space stretch out to the fullest, engulfing you in an atmosphere of excitement.



- Classic Hall (The Munich Philharmonic Hall)**
Puts you in a front row seat at the Munich Philharmonic Hall, surrounded in calm, voluptuous sound.
- Jazz Club (The Bottom Line)**
Reproduces the acoustics of sitting right in front of the stage at The Bottom Line, a popular New York City jazz club. Experience the lively, realistic throb of a wide stage.
- Rock Concert (The Roxy Theater)**
Recreates the acoustic personality of a nightclub seating for an audience of about 460.
- 5ch Stereo**
Fills the space with sound and allows all listeners to enjoy the same high-quality sound no matter where they are sitting or standing in the room. A DSP Program that is especially suitable for home parties.



- Live Sports**
In a live stereo sports broadcast, announcer voices are central, engulfed in the cheers and emotional whirl of the stadium.



- Game**
Gives TV games extra depth and surround. You can enjoy TV games with monaural or stereo sound.



Remote Control

Press **MOVIE** repeatedly to display DSP Programs.

Action
↓
Drama
↓
Sci-Fi
↓
Spectacle
↓
Theater

Remote Control

Press **MUSIC** repeatedly to display DSP Programs.

Music Video
↓
Classic Hall
↓
Jazz Club
↓
Rock Concert
↓
5ch Stereo

Remote Control

Press **SPORTS**.

Remote Control

Press **GAME**.

Sound Presence

English

Names and Functions of Parts

Top and Front

Buttons for amplifier and disc operations

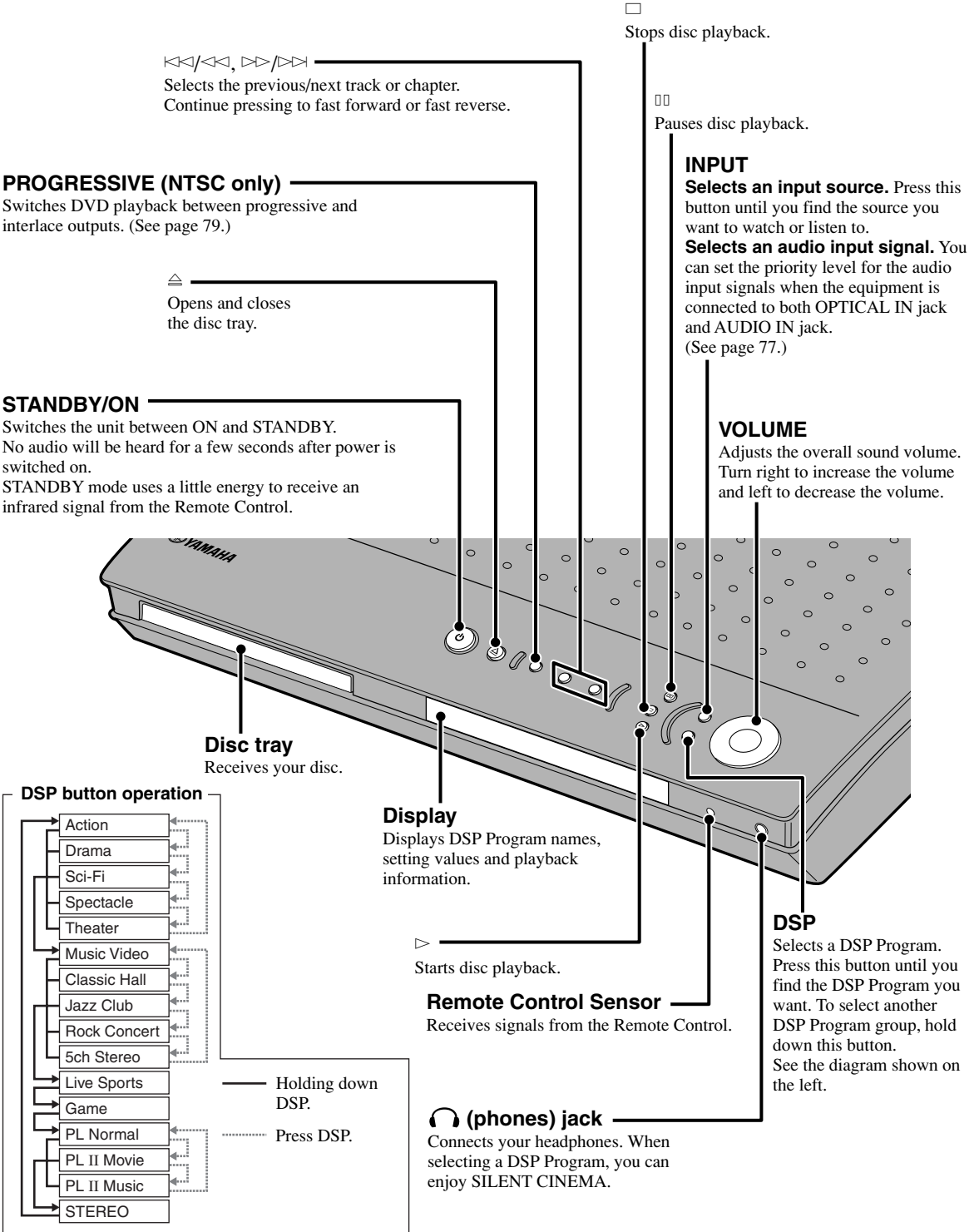

Buttons for tuner operations

Press INPUT on CinemaStation or press TUNER on the Remote Control to select Tuner mode. In Tuner mode, the buttons below function as described.

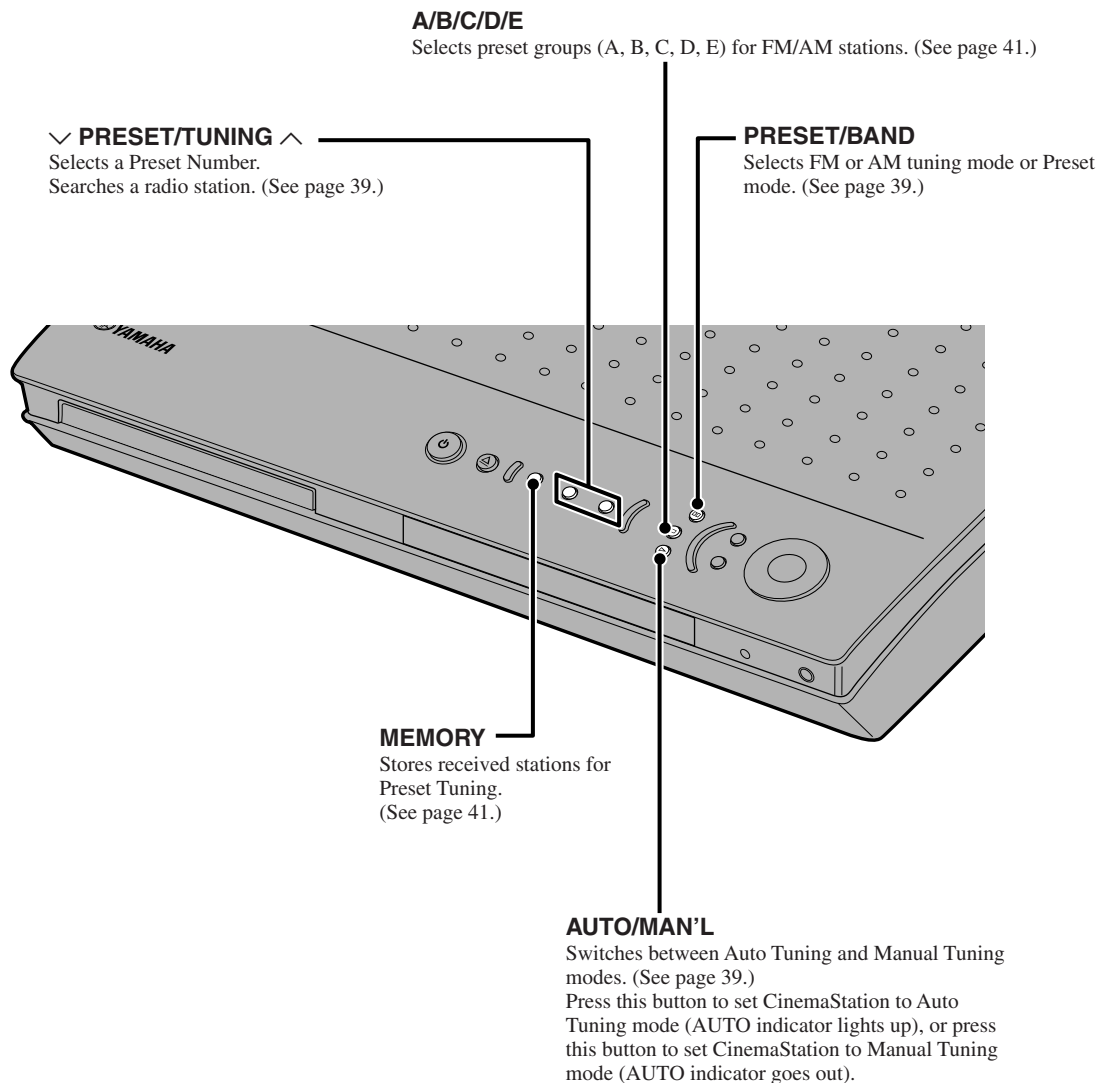

About memory backup

If you disconnect the power cord from the outlet, CinemaStation will memorize the settings listed to the right for about a week.
Set them again if those settings are erased after a week.

- Volume
- Subwoofer, Center and Surround L/R Speakers output levels (See page 58.)
- SET MENU options (See page 88.)
- Sleep Timer settings (See page 78.)
- Preset radio stations (See page 41.)
- DSP Program settings
 - Delay Time (See page 71.)
 - Dolby Pro Logic II Music settings (See page 67.)

CinemaStation Display

PROGRESSIVE

Lights up when PROGRESSIVE is activated.

DSP

Lights up when a DSP sound field program is selected.

VIRTUAL

Lights up when Virtual Cinema DSP is enabled.

SLEEP

Lights up when using the Sleep Timer.

Decoder indicator

Lights up when an internal decoder is working.

DSP Program indicator

Lights up when a DSP Program is selected.

SILENT CINEMA indicator

Lights up when using a DSP Program with headphones for SILENT CINEMA.



PCM

Lights up when playing PCM signal such as CDs.

Main Display

Shows Input Source and DSP Program names, Radio Station Frequency, Preset Numbers and other info. Shows chapter or track number, elapsed time and other info during disc playback.

TUNED

Lights up when receiving an FM/AM broadcast.

Program, Repeat indicator

PROG: Lights up during Program Play.

REP: Lights up during Repeat Play for whole disc, chapter and track.

REP ALL: Lights up during Repeat Play for whole disc.

REP A-B: Lights up during A-B Repeat.

ST

Lights up when receiving a strong FM radio signal in Auto Tuning or Auto Preset mode.

Disc indicator

DVD: Lights up while a DVD disc is set in the disc tray.

VCD: Lights up while a VCD disc is set in the disc tray.

CD: Lights up while a music CD disc is set in the disc tray.

AUTO

Lights up when using Auto Tuning or Auto Preset in Tuning mode.

Stop (Pause) indicator

Lights up when stopping or pausing disc playback.

Title, Track, Chapter indicator

TITLE: Lights up when showing the title.

TRACK: Lights up when showing the track.

CHAP: Lights up when showing the chapter.

MEMORY

Blinks when memorizing (presetting) an FM/AM radio station.

Playback indicator

Lights up during disc playback.

RDS indicator (U. K. and Europe models only)

Lights up when receiving an RDS signal. In PTY SEEK mode the PTY HOLD indicator lights up.

Remote Control Features

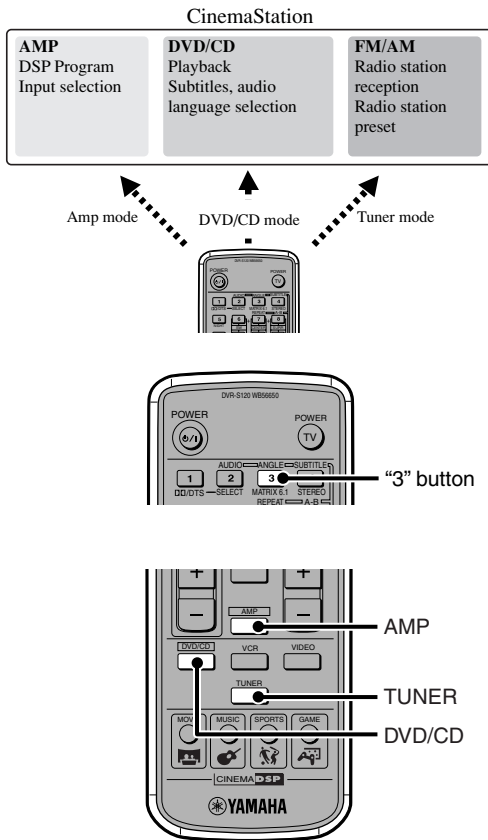

As shown on the left, CinemaStation is composed of three main parts. Remote Control button operations change depending on the mode, so it is possible to control all Amplifier, DVD/CD and Tuner functions with a single remote unit.

For example, in Amp mode the “3” button is used to select Matrix 6.1, but in DVD/CD mode, it functions as a numerical button that specifies time, track and other numbers.

The Remote Control can also operate a television or VCR connected to CinemaStation. However, it is first necessary to enter the manufacturer code for the equipment in the Remote Control’s memory. See page 83, “**Storing Manufacturer Codes in the Remote Control**”.

To switch modes, follow the steps below.

- **Amp mode:** Press AMP.
 - **DVD/CD mode:** Press DVD/CD. See page 23, “**DVD/CD Mode Button Names and Functions**”.
 - **Tuner mode:** Press TUNER.
- For details on Tuner operations, see page 39, “**Listening to the Radio**”.

Using the Remote Control

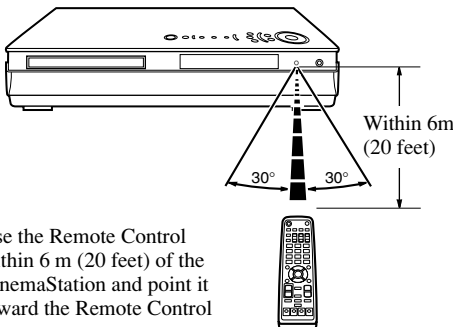

Use the Remote Control within 6 m (20 feet) of the CinemaStation and point it toward the Remote Control Sensor.

Some reminders when using the Remote Control

- Do not spill water or tea, or drop anything on the unit.
- Do not leave the unit in the following places.
 - Near a stove, bath or hot and humid place.
 - In a dusty place.
 - In an extremely cold place.

When the batteries run down, replace them

When the batteries grow old, the effective operation distance decreases considerably. When that happens, replace the batteries with two new ones. Once you take the old batteries out, replace them within two minutes to preserve the memory in the Remote Control.

Note

- Replace worn out batteries as soon as possible.
- Do not use a new battery with one that has been used before.
- Do not use different types of batteries (for example, alkaline with manganese) together. Each type of battery has its own characteristics.
- If a battery starts leaking, dispose of it immediately. Be careful not to let leaking battery acid come into contact with you or your clothing. Before inserting new batteries wipe the compartment clean.

Amp Mode Button Names and Functions

Press AMP before starting operations.

Advice

- The purple color on the Remote Control indicates Amp mode.

DD/DTS, SELECT

Switches between Dolby Digital and DTS decoders. After pressing DD/DTS, repeatedly press SELECT to select a decoder. (See page 73.)

Infrared signal transmitter

Sends an infrared signal to the CinemaStation.

POWER (⏻/⏻)

Switches the CinemaStation between ON and STANDBY.

NIGHT

Sets the CinemaStation to Night Listening mode. (See page 70.)

△, ▽, ◀, ▶

Adjusts the test tone and SET MENU.

MUTE

Turns off the sound. Press again to return to the previous sound volume. This button works in every mode.

AMP

Puts the Remote Control in Amp mode.

Input Selection buttons

Selects a source to operate with the Remote Control. (See page 27.) To operate a VCR, you need to set the manufacturer code for the VCR button.

MATRIX 6.1

Sets the Matrix 6.1 decoder. (See page 64.) In most cases, the Matrix 6.1 decoder works automatically once Dolby Digital Surround EX or DTS ES discs start playing. However, for some disc types, you may have to set the decoder using this button.

STEREO

Switches between normal stereo sound and audio with a sound field effect. (See page 74.) Select STEREO to listen to audio with no sound field effect from the Front L/R Speakers.

Volume level buttons

Adjust speaker volume level. (See page 58.)
SW +/-: Adjusts the Subwoofer volume.
CENTER +/-: Adjusts the Center Speaker volume.
SURR +/-: Adjusts the volume of the Surround Speakers.

SLEEP

Sets the Sleep Timer. (See page 78.)

SET MENU

Enters the SET MENU. (See page 89.)

TEST

Outputs a test tone. (See page 58.)

VOLUME +/-

Adjusts the overall volume level. Press + to increase the volume and - to decrease the volume.

DSP Program buttons

Selects one of four DSP Programs: MOVIE, MUSIC, SPORTS or GAME. (See pages 16 and 17.) The MOVIE and MUSIC groups contain multiple sound field programs. Press the button repeatedly and select the effect you like.



DVD/CD Mode Button Names and Functions

Press DVD/CD before starting operations.

Advice

- The green color on the Remote Control indicates DVD/CD mode.

Number buttons (1-9, 0)

Input numerals for track numbers and others.

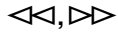

Fast forwards and reverses.



Moves to the start of a disc track.

ON SCREEN

Shows the On Screen Menu on the TV.

STATUS

Shows type of disc, play/stop status, playing time and other info.

DVD/CD

Puts the Remote Control in DVD/CD mode.

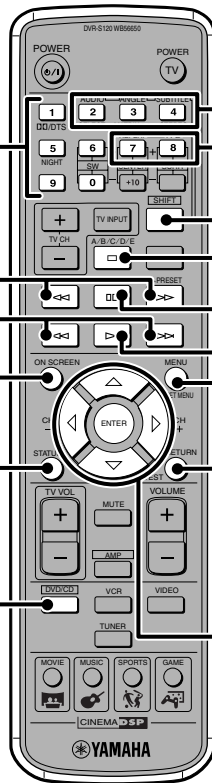

While holding down SHIFT, press a button below to enable the corresponding operation.

- 7 button:** Enables Repeat Play.
- 8 button:** Enables settings for A-B Repeat.
- AUDIO:** Switches the audio language of the DVD video.
- ANGLE:** Switches the angle of the DVD video.
- SUBTITLE:** Switches the subtitle language of the DVD video.

(Stop)

Stops disc playback.

(Pause)

Pauses disc playback.

(Play)

Starts disc playback.

MENU

Shows the Disc Menu on the TV.

RETURN

Returns the Disc Menu to one position before the current screen.

△, ▽, ◀, ▶/ENTER

Adjusts On Screen Menu and other settings.

Using the On Screen Menu

The On Screen Menu includes Preference, Toolbar and Setup. Perform operations using the TV screen.

Preference: You can adjust picture contrast, sharpness and other picture qualities of the DVD or video CD to your liking.

Toolbar: You can use Program Play, Disc Navigation and other handy playback features.

Setup: You can adjust DVD playback controls such as the default subtitle language and screen size.

- 1 Press ON SCREEN.**
The On Screen Menu appears.

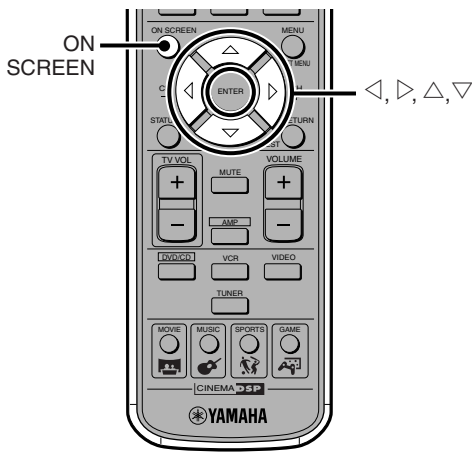

On Screen Menu

Useful functions

- Setting the Status Display
- Adjusting the picture quality such as contrast or brightness
- Using Program Play
- Using zoom and angle view
- Selecting audio and subtitle languages, and learning about the disc structure
- Finding a scene or track to view or listen to
- Using the Parental Control
- Fine-tuning TV screen settings
- Setting default subtitle and audio languages
- Setting Playback Control

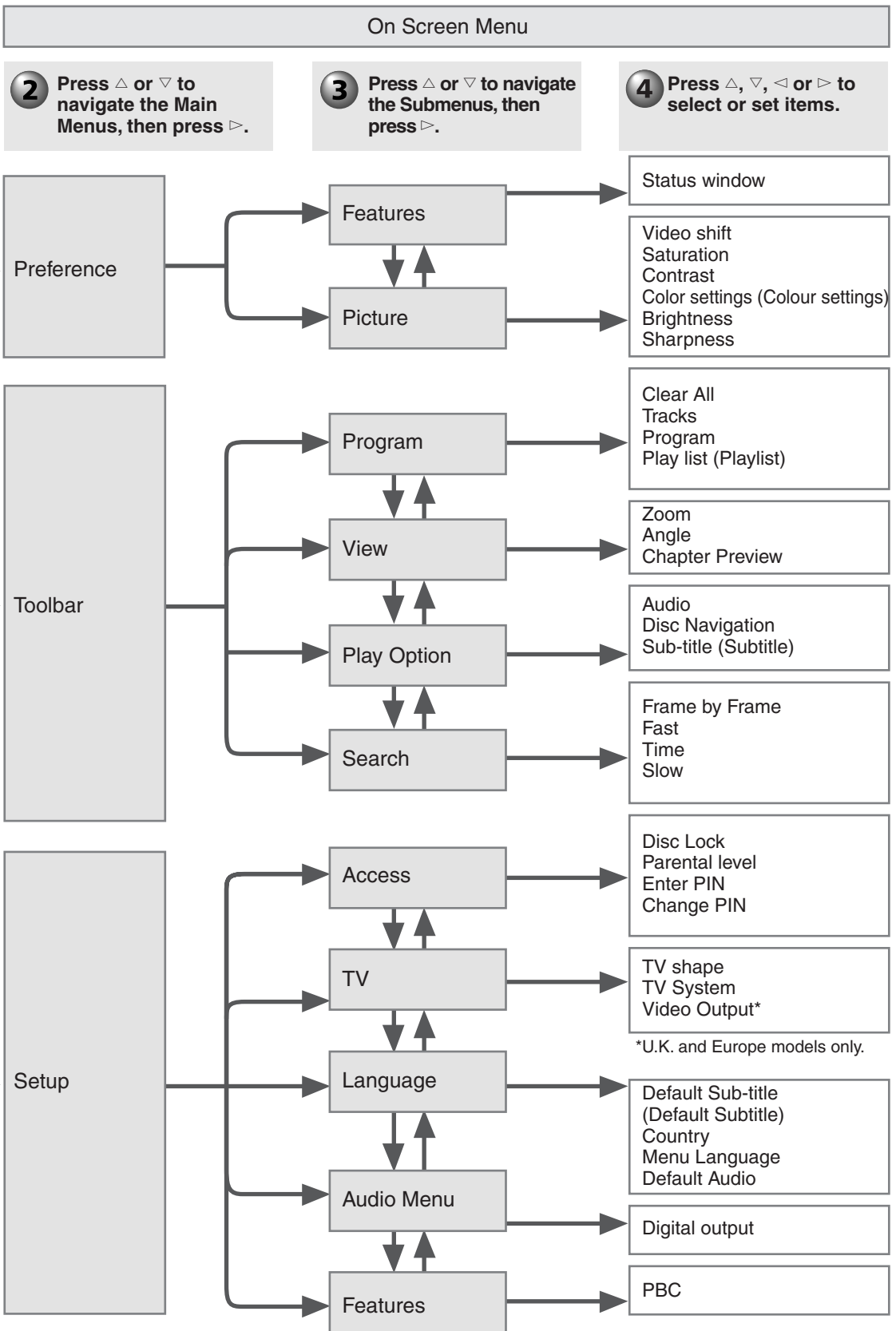

Refer to On Screen Menu Guide on pages 94 and 95.

Selecting the Equipment

CinemaStation provides you with a variety of playback options, including CDs, video discs, music CDs and MP3 discs. You can connect a VCR or video game console and increase your home entertainment possibilities. For connecting the equipment you want, follow the chart below.

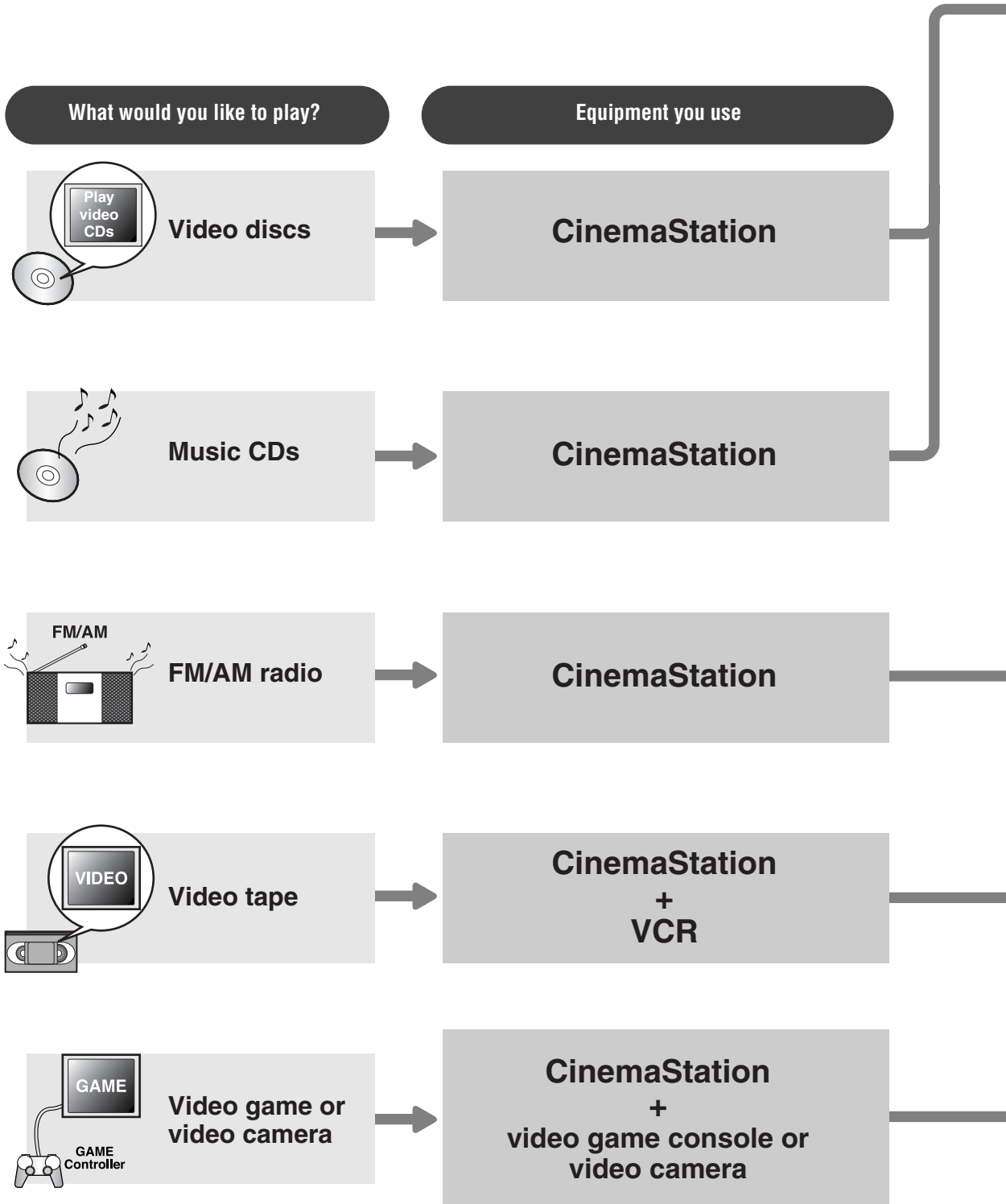

Making the connections

Selecting the equipment

Complete the steps on pages 8 and 9, "Connecting the Speakers and TV".

Press DVD/CD on the Remote Control.

To play a video disc, perform steps 1 to 10 on pages 10 to 12, "Viewing a DVD".
To play a music disc, perform steps 4 to 10 on pages 10 to 12, "Viewing a DVD".

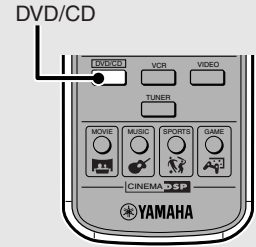

Complete the steps on pages 8 and 9, "Connecting the Speakers and TV". Then connect the indoor FM Antenna and AM Loop Antenna to CinemaStation. See page 38, "Connecting the Antennas".

Press TUNER on the Remote Control.

To tune in your favorite channel, see page 39, "Listening to the Radio".

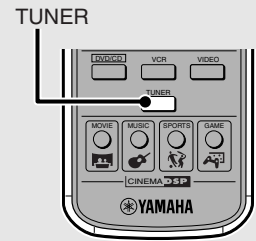

Complete the steps on pages 8 and 9, "Connecting the Speakers and TV". Then connect a VCR to CinemaStation. See page 46, "Connecting Video Equipment".

Press VCR on the Remote Control.

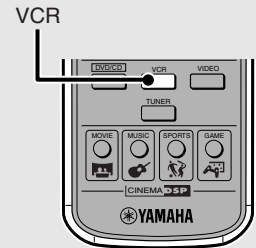

Complete the steps on pages 8 and 9, "Connecting the Speakers and TV". Then connect a game console or video camera to CinemaStation. See page 46, "Connecting Video Equipment".

Press VIDEO on the Remote Control.

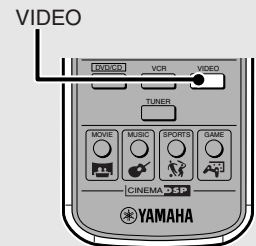

Playback Methods



DVD/CD

CinemaStation provides you with a variety of playback methods, including the ability to select and quickly find a scene or tune.

Start operations after first pressing DVD/CD. CinemaStation enters DVD/CD mode to play a disc.

In this manual, each type of disc has its own mark as shown below.

DVD Video	Video CD	Music CD
DVD-V	VCD	CD

Selecting a Scene or Tune

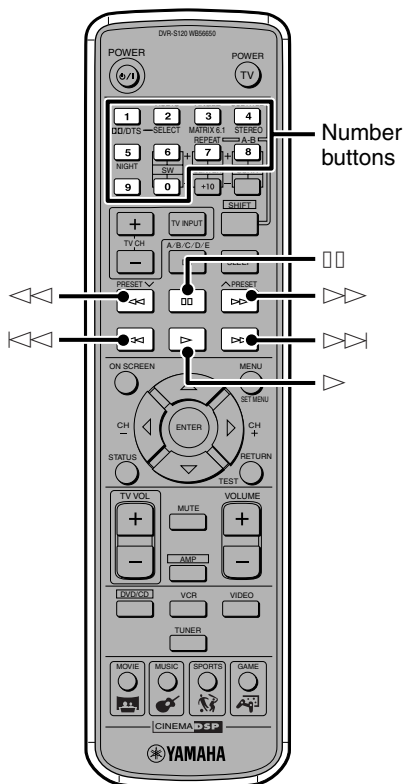

To skip chapters and tracks

To return to the previous chapter or track: Quickly press **twice.**

When you press only once, playback starts from the beginning of the currently playing chapter or track.

To advance to the next chapter or track: Press .

To specify a track

Enter the track number with the Number buttons.

For a 1-digit number use buttons 1 to 9. For a 2-digit number, use the buttons 1 to 9 for the second digit place, and buttons 1 to 9 and 0 for the first digit place.

For example:

To select track 17 press the 1 button followed by the 7 button.

To select track 20 press the 2 button followed by the 0 button.

To Fast Forward and Fast Reverse

Perform while playing.

To Fast Reverse: Press .

Each time you press the button, the speed changes (4X, 8X or 32X).

To Fast Forward: Press .

Each time you press the button, the speed changes (4X, 8X or 32X).

To pause playback

Press while playing.

Press to return to normal playback.

Frame Advance DVD-V VCD

1 Press **⏸** to pause playback.

2 Press **⏩**.

To return to normal play
Press **▶**.

Slow Advance/Reverse DVD-V VCD

1 Press **⏸** to pause playback.

2 To return press **⏪** or to advance press **⏩**.
Each time you press the button, the speed changes (0.125X, 0.25X or 0.5X).

To return to normal play
Press **▶**.

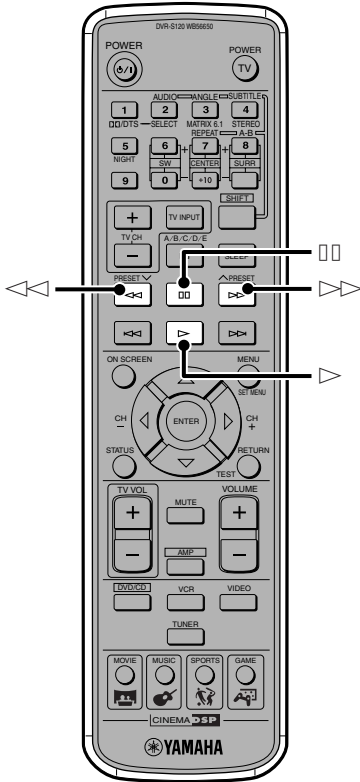

Advice

- You can also use the On Screen Menu to operate Frame Advance, Fast Forward/Reverse and Slow Advance/Reverse. In addition to those, you can use Frame Reverse from the On Screen Menu.
See pages 94 and 95, "On Screen Menu Guide".

Note

- The Skip feature may not work properly when using Playback Control to play a video CD.
- If you use Fast Forward/Reverse while playing a Dolby Digital or DTS disc, the Speakers do not output any sound.
- Slow Reverse is not available for a video CD.

Specify an elapsed time for playback (Time Search)

Perform operations using the TV On Screen Menu.

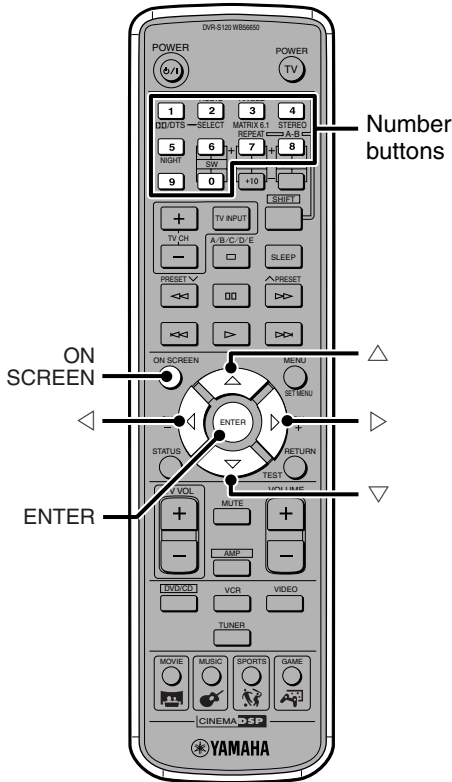

- 1 Press ON SCREEN.**
Make sure that "Toolbar" is selected.



- 2 Press > to select "Play Option".**

- 3 Press > to select "Search".**

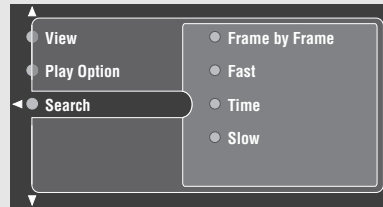

- 4 Press > to select "Time".**

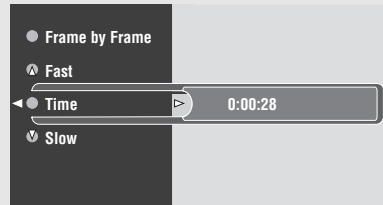

- 5 Press > or < to select 0:00:00 (hour, minute or second) with the cursor. Then enter time with the Number buttons.**
You can specify the time only within the current track or title, not the whole disc.

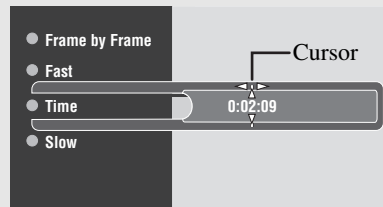

- 6 Press ENTER, then press ON SCREEN to turn off the On Screen Menu.**

When pressing ENTER, playback starts from the time position you specified in step 5.

Customizing Playback Order (Program Play) DVD-V VCD CD

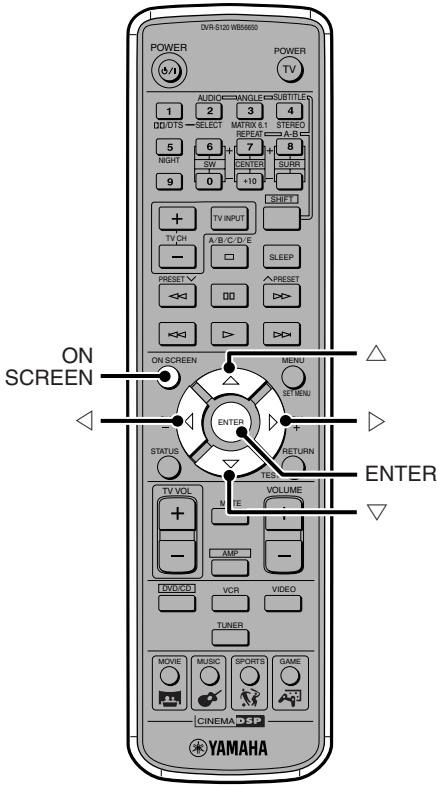

Playback your favorite chapters and tracks in the order you want.

Perform operations using the TV On Screen Menu.

- 1 Press ON SCREEN.**
Make sure that "Toolbar" is selected.



- 2 Press \triangleright , then repeatedly press \triangle to select "Program".**

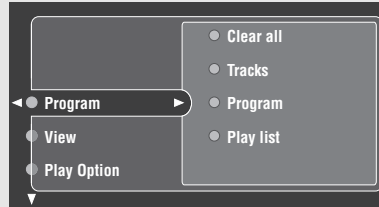

- 3 Press \triangleright , then press \triangle to select "Tracks". Then press \triangleright .**

Ex. DVD video



Ex. CD



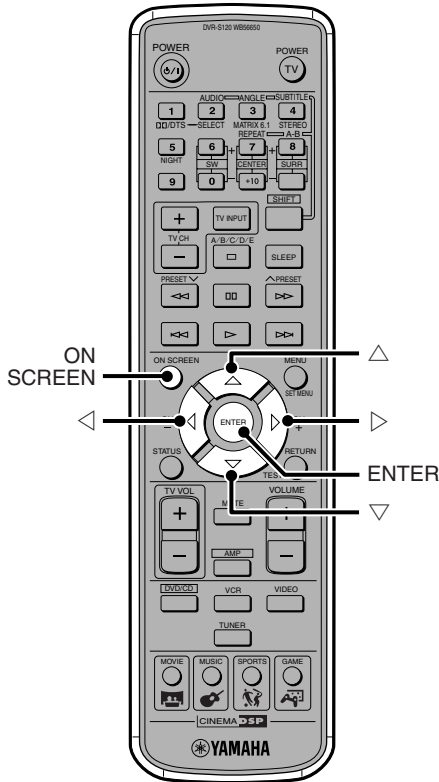

4 Select the chapter or track to add to Program Play.

Ex. DVD video

Press Δ or ∇ to select the title number to add, then press ENTER.

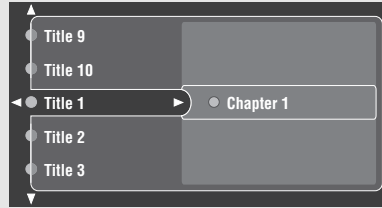

Press Δ or ∇ to select the chapter number to add, then press ENTER.

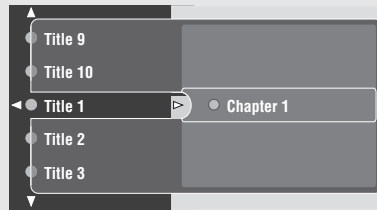

Ex. CD

Press Δ or ∇ to select the track number to add, then press ENTER.

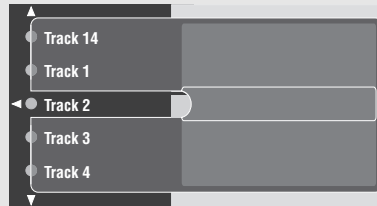

5 Perform step 4 until you add all desired chapters or tracks.

6 Press ON SCREEN to turn off the On Screen Menu.

Program Play starts. Press \triangleright to start Program Play when Program Play does not start.

Advice

- Once Program Play is set, the PROG indicator lights up in the CinemaStation Display.

Note

- Playback Control is not available during Program Play of a video CD.

Check Program Play content

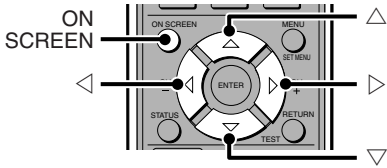

1 Perform steps 1 to 2 in “Customizing Playback Order (Program Play)” on page 31.

2 Press **▷**, then press **▽** to select “Play list” (“Playlist”). Then press **▷**.
The list appears in the specified order.

3 Press **△** or **▽** to scroll through the list.

Turn on/off Program Play

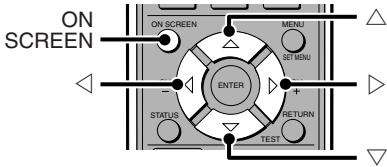

CinemaStation automatically sets Program menu item to “On” after Program Play starts. The setting does not change even if Program Play finishes, so you can restart Program Play by pressing **▷**.

To return to normal playback, select “Off” for Program menu item in the On Screen Menu. Even if you set it to “Off”, the playlist remains in the memory, so you can use the previous play list by setting it to “On”.

1 Perform steps 1 to 2 in “Customizing Playback Order (Program Play)” on page 31.

2 Press **▷** to select “Program”. Then press **▷**.

3 Press **△** or **▽** to select “On” or “Off”.

Delete Program Play

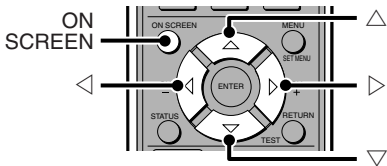

1 Perform steps 1 to 2 in “Customizing Playback Order (Program Play)” on page 31.

2 Press **▷**, then press **△** to select “Clear All”. Then press **▷**.
“Clear” changes to “Cleared”, and all Program Play content is deleted.

Repeating a Disc or Track (Repeat Play) DVD-V VCD CD

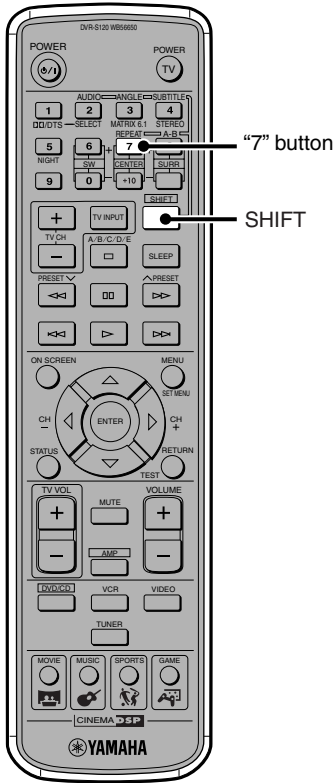

You can repeat a favorite track, chapter or entire disc. You can also repeat Program Play and certain parts you specified as many times as you like.

1 Play back a disc.
To repeat a chapter or track first start playing it. See page 28, “**Selecting a Scene or Tune**”.

2 While holding down SHIFT, press the “7” button to select Repeat mode.
Every time you press the button, the display on the TV screen changes as shown below.

DVD video

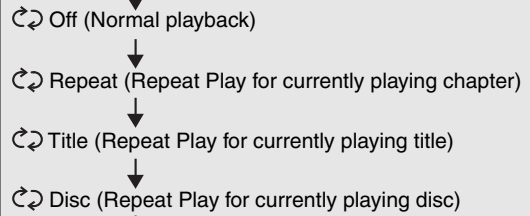

Video CD/CD

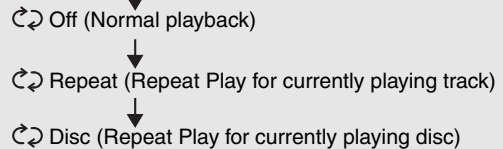

Advice

- Once Repeat Play is selected, the Repeat mode indicator lights up in the CinemaStation Display.
 - REP indicates title, chapter and track repeat
 - REP ALL indicates entire disc repeat

Note

- Repeat Play may not work properly with some DVD video discs.
- Repeat Play will not work during Menu Play of a video CD that is using Playback Control.

Repeat between two points (A-B Repeat) DVD-V VCD CD

Specify the start and end of a favorite segment (points A and B) then playback between those two points as much as you like. You can specify a part within one title or track.

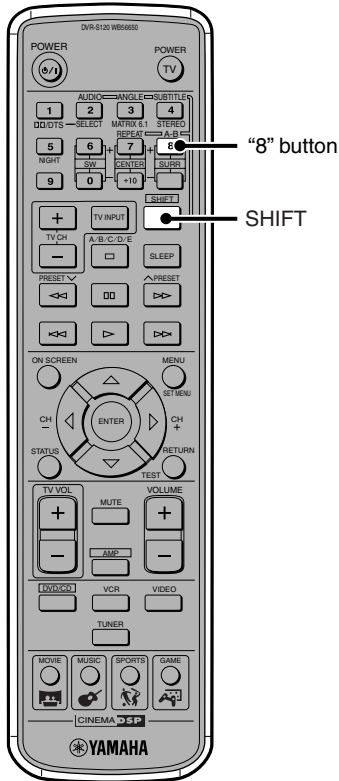

1 Play back a disc.

2 While holding down **SHIFT** at the start position (point A), press the **"8"** button.

“↺ Repeat A” appears on the TV screen.

Advice

- The REP A- indicator lights up in the CinemaStation Display.

3 While holding down **SHIFT** at the end position (point B), press the **"8"** button.

“↺ Repeat A/B” appears on the TV screen. A-B Repeat starts.

Advice

- The REP A-B indicator lights up in the CinemaStation Display.

To return to normal playback

While holding down **SHIFT**, press the **"8"** button.

“↺ A/B Off” appears on the TV screen, and A-B Repeat cancels.

Note

- A-B Repeat may not work properly with some DVD video discs.
- You can use A-B Repeat only within one track or title.

Using a Disc Menu

Many DVDs or video CDs that have Playback Control include an original menu. You can use the menu for skipping to a favorite title or chapter and switching audio or subtitle language.

Navigate a DVD Disc Menu

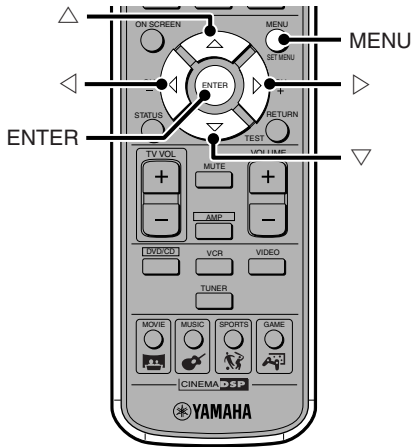

1 Press MENU.
A menu appears on the TV screen.

Advice

- Depending on the disc, a menu may automatically pop up when playback starts.

2 Select items with Δ , ∇ , \triangleleft , \triangleright and press ENTER.
If operating instructions appear in the menu, follow them and repeat step 2.

Use Video CD Playback Control (PBC) (Menu Play)

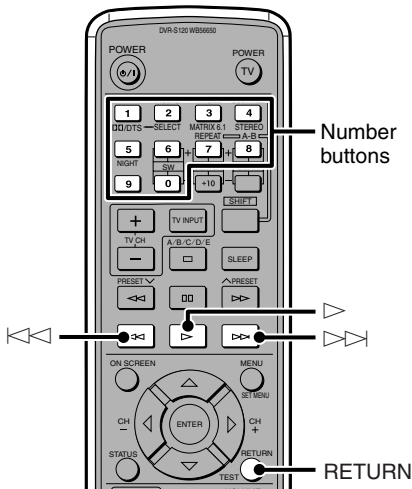

If you play a video CD that includes Playback Control, a menu will appear on the TV screen. From the menu you can select the scenes and information that interest you. In this manual, using the menu screen to play media is called Video CD Menu Play.

- Number buttons: For selecting the desired item.
- RETURN: For returning to the previous screen.
- \triangleright : For playing the selected item.
- \triangleleft : For moving to the next screen.
- \triangleleft : For returning to the previous screen.

Note

- Playback Control is not available during Program Play.

MP3 Playback Features

You can play MP3 music that was recorded onto a CD-R or CD-RW by a computer.

Advice

- Depending on recording conditions some discs cannot be played.

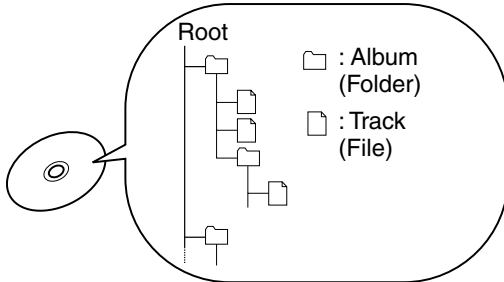

Disc Structure

Since the MP3 format can store several albums on a disc, a folder is assigned to an “Album”, and a file is assigned to a “Track”.

Repeat Play

You can use Track Repeat and Album Repeat to repeat the music. See page 34, “**Repeating a Disc or Track (Repeat Play)**”.

Playback status on the TV screen

You can check the playback status (disc type, now playing/ stopped) along with the total and elapsed playing of the current track on the TV screen.

Advice

- CinemaStation is compatible with a bit rate range of 32, 64, 96, 128, 192 or 256 kbps. CinemaStation is also compatible with variable bit rate encoded MP3 files.
- CinemaStation is compatible with a sampling frequency of 32, 44.1 or 48 kHz.

Note

- In some cases, you may not be able to play tracks in the order they were recorded.

Connecting the Antennas

CinemaStation includes an AM Loop Antenna and indoor FM Antenna. Use the supplied antennas in areas with good radio wave reception. Connect each antenna into its jack properly.

Connecting the FM Antenna

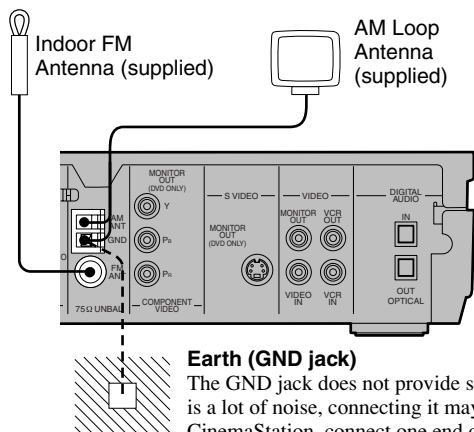

Connect the supplied indoor FM Antenna to the FM ANT jack.

When connecting an outdoor FM antenna

Use the antenna's coaxial cable and a commercially available F-type connector to connect the antenna to the FM ANT jack. For details, ask the shop where you bought the outdoor antenna.

Earth (GND jack)

The GND jack does not provide secure grounding. However when there is a lot of noise, connecting it may improve reception. To ground CinemaStation, connect one end of a vinyl coated wire to the GND jack and the other end to a commercially available grounding rod or copper sheet, and bury the rod or sheet in damp earth.

Connecting the AM Loop Antenna

- 1 Attach the Antenna to its stand.

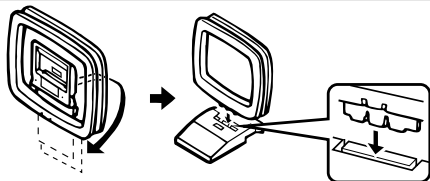

- 2 Open the AM ANT and GND jack levers to the right. Insert the AM Loop Antenna's cord cores into the AM ANT and GND jacks.

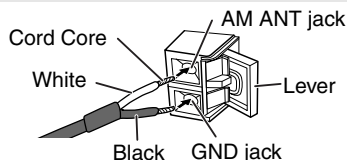

- 3 Close the lever to fasten the cord. Pull the cord lightly to make sure it is properly fastened.

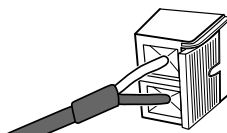

- 4 Adjust the Antenna left and right and find the best position for reception.



Advice

- The AM Loop Antenna can be detached from its stand and attached to a wall.
- To improve reception, we recommend that you install an outdoor antenna. For details, contact your local Yamaha sound products service center.

Note

- Install the supplied indoor FM Antenna and AM Loop Antenna away from this system.
- Even if you connect an outdoor AM antenna, be sure to still use the AM Loop Antenna.

Listening to the Radio

CinemaStation provides several methods for tuning radio stations to help you find channels as easy as you can.

Selecting the Radio Tuner

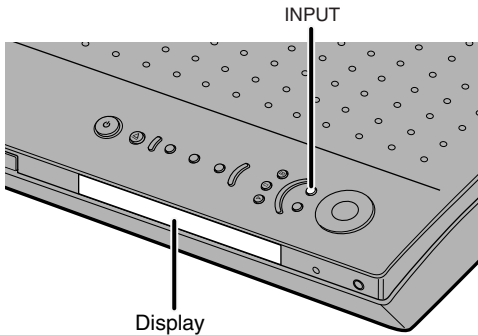

Press INPUT repeatedly on CinemaStation until TUNER appears. The input source changes to Tuner (Radio) and you can listen to AM/FM broadcasts.

Advice

- You can also press TUNER on the Remote Control to change the input source to Tuner.

Selecting Radio Stations

You have two ways to select radio stations, Auto Tuning and Manual Tuning. Auto Tuning is quick and handy to use when radio signal reception is strong.

Select stations automatically (Auto Tuning)

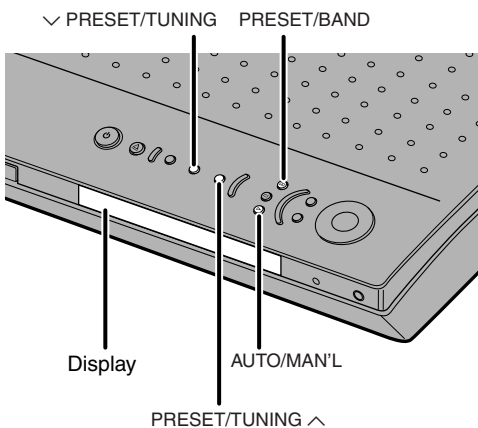

1 Press PRESET/BAND to select either FM or AM.

Each time you press, the mode changes in the order as follows: FM (Tuning mode) → AM (Tuning mode) → (Preset mode) → FM (Tuning mode) → ...

Advice

- If the colon (:) beside the Band indicator goes out, that means CinemaStation is in Tuning mode. Make sure the colon (:) is not lit up.

2 Press AUTO/MAN'L to set CinemaStation to Auto Tuning mode.

When CinemaStation is set to Auto Tuning mode, the AUTO indicator lights up in the CinemaStation Display.

3 Press PRESET/TUNING ^ to select the radio station you want to receive.

Press ^ to search for high-frequency stations or press v to search for low-frequency stations.

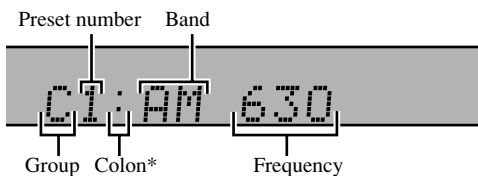

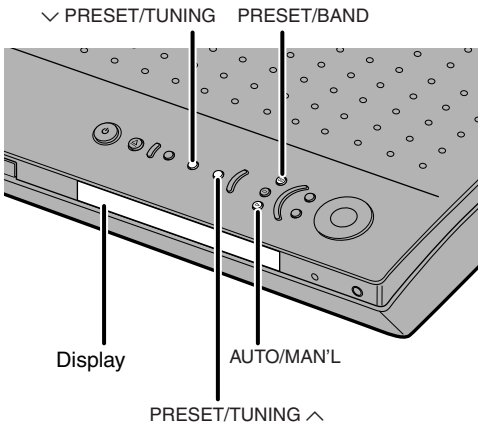

* Goes out in Tuning mode, lights up in Preset mode.

Select your favorite stations by hand (Manual Tuning)



For stations with weak radio signals, tune manually.

- 1** Perform step 1 in “Select stations automatically (Auto Tuning)” on page 39.
- 2** Press **AUTO/MAN'L** to set CinemaStation to Manual Tuning mode.
 When CinemaStation is set to Manual Tuning mode, the AUTO indicator goes out from the CinemaStation Display.
- 3** Press **PRESET/TUNING**   to select the radio station you want to receive.
 Hold down the button to continue the tuning search.

Advice

- If the radio waves are weak and Auto Tuning doesn't work, tune manually (Manual Tuning).
- When Auto Tuning finds a radio station, the TUNED indicator lights up and the frequency appears.
- Manually tuning in to an FM station will automatically change the reception mode to monaural to increase the signal quality.

Setting Channels in Advance (Preset)

Presetting radio stations in memory helps you tune the preset radio stations using a few simple button operations.

Automatically preset FM stations in advance (Auto Preset)

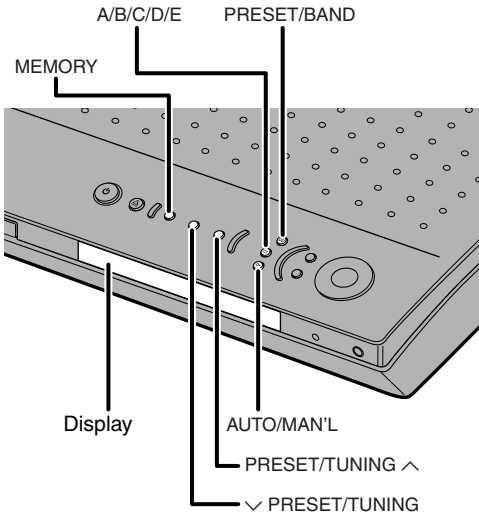

Up to 40 stations (5 Groups × 8 Stations) can be automatically preset.

- 1 Press PRESET/BAND to select FM.**
- 2 Press AUTO/MAN'L to make the AUTO indicator light up.**
- 3 Keep pressing MEMORY down for about 3 seconds.**
The Preset Number, MEMORY and AUTO indicators blink. After a few seconds, Auto Preset starts at the frequency currently displayed toward the higher frequency.
When Auto Preset finishes the frequency of the last radio station memorized appears.

Customizing Auto Preset method

You can specify the Preset Group or number to start tuning. You can also start Auto Tuning at the frequency currently displayed toward either the lower or higher frequency.

- 1 Perform steps 1 and 2 above, in “Automatically preset FM stations in advance (Auto Preset)”.**
- 2 Press MEMORY for about 3 seconds, then press A/B/C/D/E and PRESET/TUNING ^/v to select the Preset Number you want to memorize first.**
Auto Preset will stop when the number memorized reaches 40 radio stations.
- 3 Press PRESET/BAND to turn off the colon (:), then press PRESET/TUNING ^/v.**
When pressing v, Auto Preset starts at the frequency currently displayed toward the lower frequency, and when pressing ^, Auto Preset starts at the frequency currently displayed toward the higher frequency.

Manually preset stations in advance (Manual Preset)

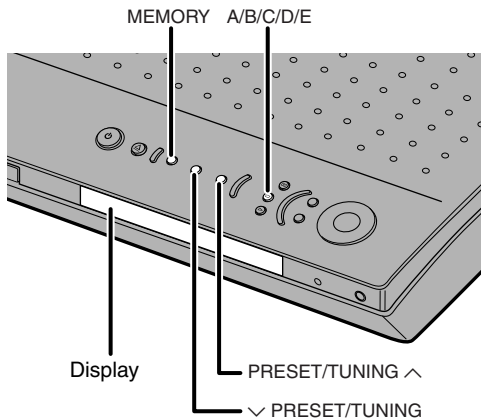

You can manually preset up to 40 radio stations.

- 1 Select radio stations you want to preset. See page 39, “Selecting Radio Stations”.**
The frequency and broadcast band (FM or AM) of the tuned-in station appear in the CinemaStation Display.
- 2 Press MEMORY.**
The MEMORY indicator blinks for about 5 seconds in the CinemaStation Display, which means CinemaStation is ready to preset.
- 3 While the MEMORY indicator is blinking, press A/B/C/D/E to select the Preset Group (A to E).**
The Group appears. Check that the colon (:) beside the band indicator lights up.
- 4 While the MEMORY indicator is blinking, press PRESET/TUNING ^/∨ to select a Preset Number (1 to 8).**
Press ^ for a larger number and ∨ for a smaller number.
- 5 While the MEMORY indicator is blinking, press MEMORY.**
The selected Preset Group and Number, broadcast band (FM or AM) and frequency appear in the CinemaStation Display.
- 6 Repeat steps 1 to 5 to manually preset other radio stations.**

Advice

- When presetting a radio station, you can set the frequency and reception mode (stereo/monaural) at the same time.
- You can change the order of preset FM radio stations later. See page 43, “**Changing the Order of Preset Stations**”.
- If the number of radio stations that have been preset is less than 40, Auto Preset automatically stops after searching the whole frequency range.

Note

- If a new radio station is preset for a Preset Number, the previously preset station for the Preset Number is deleted.
- In Auto Preset, only FM radio stations with a strong signal are set. To preset radio stations with a weak signal set reception mode to monaural and preset manually.

Selecting a Preset Station (Preset Tuning)

You can tune in a radio station simply by selecting its Preset Number.

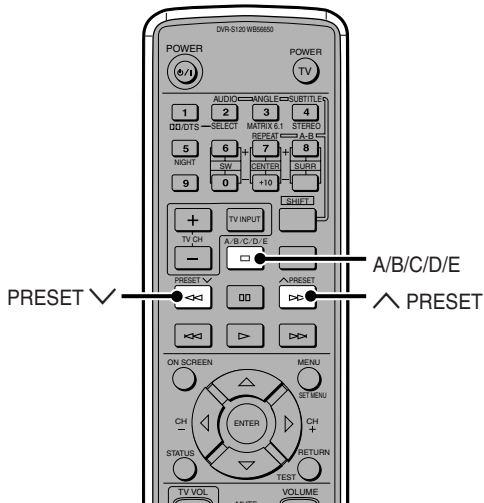

1 Press A/B/C/D/E repeatedly to select the station's Preset Group.
The Preset Group that appears in the CinemaStation Display changes each time you press A/B/C/D/E.

2 Press PRESET $\checkmark\checkmark$ to select the Preset Number.
The Preset Group and Number, broadcast band (FM or AM) and frequency appear in the CinemaStation Display with the TUNED indicator lit up.

Advice

- You can also perform Preset Tuning by repeatedly pressing A/B/C/D/E and PRESET/TUNING $\checkmark\checkmark$ on CinemaStation.

Changing the Order of Preset Stations

You can also change the order of preset stations.

Below is an example of the steps for switching the E1 and A5 radio stations.

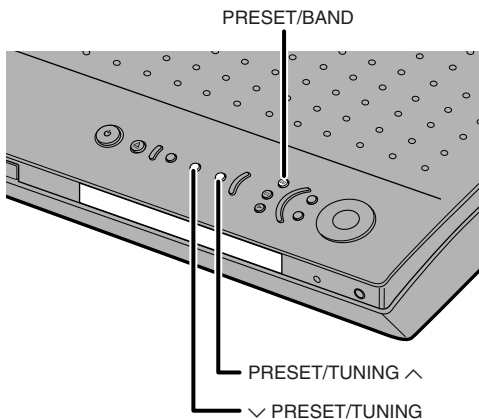

1 Tune in the radio station preset to E1.
Review the procedure above, "Selecting a Preset Station (Preset Tuning)".

2 Press PRESET/BAND for about 3 seconds.
E1 and the MEMORY indicator will blink in the CinemaStation Display.

3 Tune in the radio station preset to A5 using A/B/C/D/E and PRESET/TUNING $\checkmark\checkmark$.
A5 and the MEMORY indicator will blink in the CinemaStation Display.

4 Press PRESET/BAND.
"EDIT E1-A5" will appear in the CinemaStation Display and the preset stations will exchange places.

Receiving RDS Stations (U.K. and Europe models only)

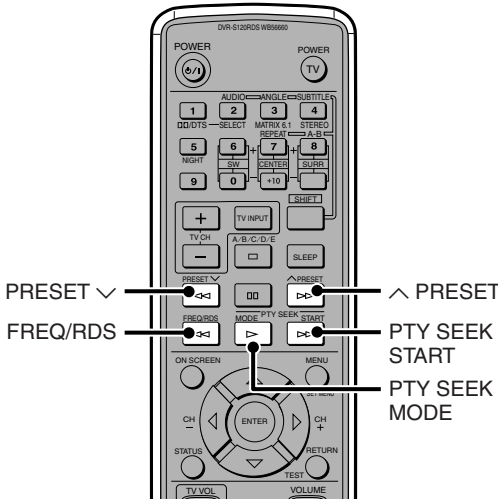

U.K. and Europe models

RDS (Radio Data System) is a transmission system for FM stations used in many countries.

RDS transmissions contain various types of information, including PS (Program Service), PTY (Program Type), RT (Radio Text), and CT (Clock Time). RDS works through cooperation among broadcasting stations.

FREQ/RDS

Press this button when receiving an RDS station to switch between frequency and RDS mode. The RDS mode display may include PS, PTY, RT and CT, depending on the information a radio station provides.

PTY SEEK MODE

Press this button to set the program type to search for.

PTY SEEK START

Once the program type has been selected in PTY SEEK mode, press this button to begin the search.

RDS Modes

RDS supports four types of information: PS, PTY, RT and CT.

PS (Program Service)

Shows the name of the RDS station broadcasting.

PTY (Program Type)

Divides RDS broadcasts into the 15 genres shown at right.

RT (Radio Text)

Shows RDS broadcast information (including song title, artist name) using up to 64 letters and numbers plus the umlaut letter. If the radio text contains other characters, they will appear with an underbar.

CT (Clock Time)

Shows the current time updated once a minute. If data flow is interrupted, CT WAIT will appear.

PTY (Program Type)

NEWS	News
AFFAIRS	Current Affairs
INFO	General Information
SPORT	Sports
EDUCATE	Education
DRAMA	Drama
CULTURE	Culture
SCIENCE	Science
VARIED	Light Entertainment
POP M	Pops
ROCK M	Rock
M.O.R. M	Middle-Of-the-Road Music (easy-listening)
LIGHT M	Light Classics
CLASSICS	Serious Classics
OTHER M	Other Music

Change RDS Mode

There are four RDS display modes. When an RDS station is broadcasting, PS, PTY, RT or CT mode indicators corresponding to the services provided light up in the CinemaStation Display. Press **FREQ/RDS** repeatedly to change among the modes supported by the currently tuned RDS station.

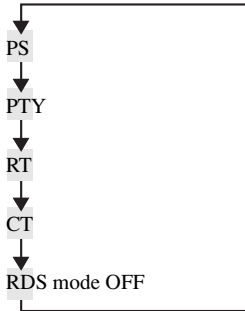

Note

- When an RDS station is broadcasting, do not press **FREQ/RDS** until one or more mode indicators light up in the CinemaStation Display. If you press **FREQ/RDS** before the mode indicators light up, CinemaStation may not be able to change modes.
- RDS information not provided by a station cannot be selected.
- If the RDS station's signal transmission is too weak, CinemaStation may not be able to use the service fully. In particular, radio text uses a lot of bandwidth, so it may not be available even when other modes are selectable.
- RDS information may not transmit under poor conditions. In this case, press **AUTO/MAN'L** to set CinemaStation to Manual Tuning mode. This changes reception to monaural and may help RDS information reappear when you switch to RDS display mode.
- If outside interference disrupts an RDS station broadcast, RDS information may suddenly disappear and "...WAIT" appears in the CinemaStation Display.

About PTY SEEK

When you select the program type, CinemaStation automatically searches through all preset stations currently broadcasting for that type.

- 1 Press PTY SEEK MODE to set CinemaStation to PTY SEEK mode.**
The program type of the tuned in station or **NEWS** blinks in the CinemaStation Display.
- 2 Press PRESET $\wedge\vee$ to select the program type you want.**
Your program type selection appears in the CinemaStation Display.
- 3 Press PTY SEEK START to start searching all preset RDS stations.**
The selected program type flashes and the **PTY HOLD** indicator lights up while the search is in progress.
If the search finds a station that matches the program type you selected, CinemaStation will tune it in.
If the station tuned in is not the one you want press **PTY SEEK START** again to continue the search for other stations broadcasting the program type you selected.

To cancel steps 1 or 2
Press **PTY SEEK MODE** twice.

Connecting Video Equipment

Connect a VCR to CinemaStation to play or dub videos. You can also connect a game console or video camera.

Connecting a Game Console or VCR

Please...

- Always read the owner's manual of any equipment you want to connect.

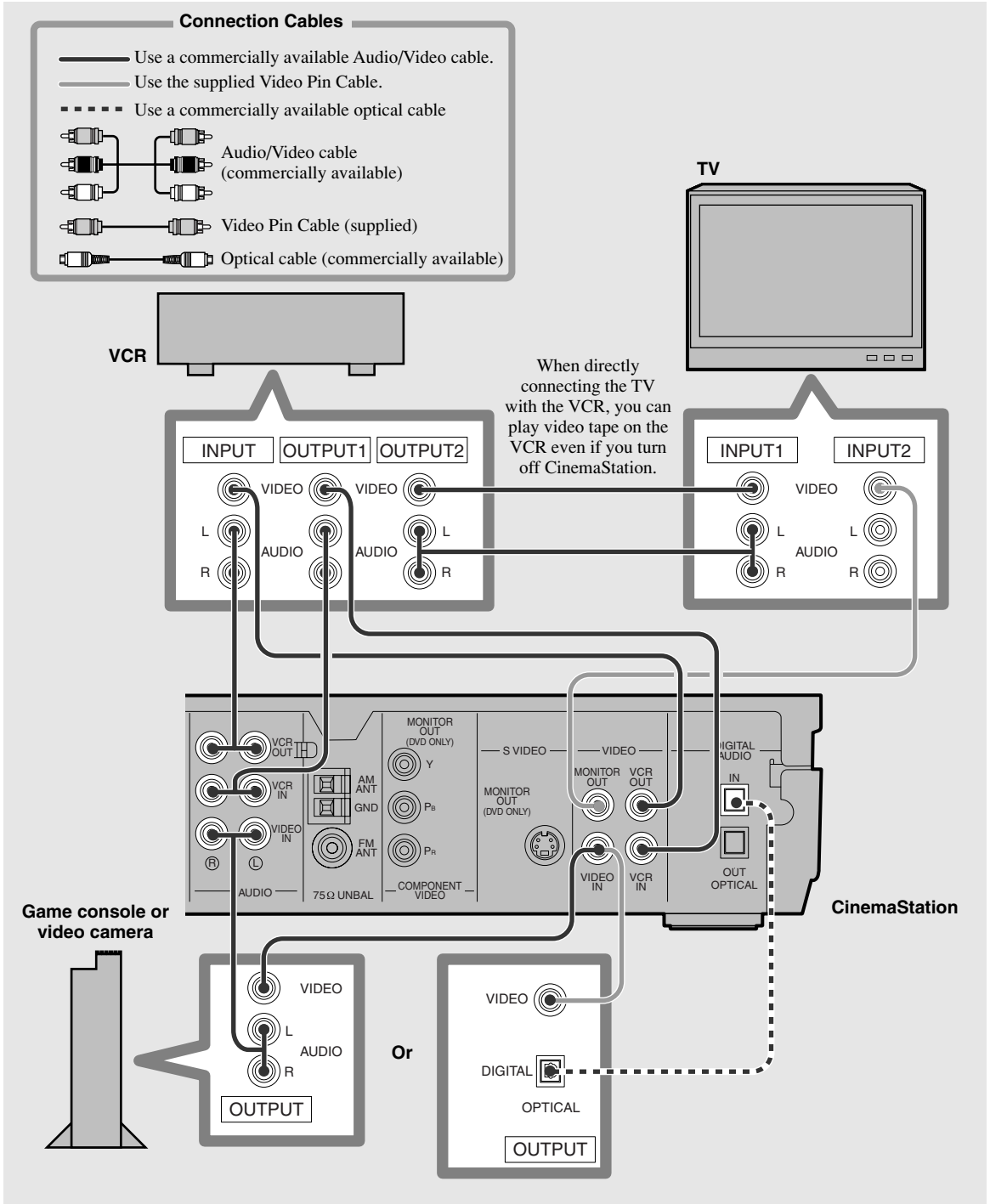

Notes on the audio jacks

- You cannot simultaneously use both IN and OUT jacks when the jack names are the same as each other. For example, the signal input from the VCR IN jack does not output from the VCR OUT jack.
- CinemaStation's digital and analog signal circuits are independent of each other, so analog input signals can only output from analog output jacks and digital input signals can only output from digital output jacks.

Notes on recording and playing video

- Perform a test recording before recording.
- Do not press ON SCREEN during recording a DVD video. If you press ON SCREEN, the On Screen Menu appears, and both the video and On Screen Menu will be recorded.
- It is not possible to record DSP effects.
- When you turn off the connected VCR power, playback sound may become distorted and the volume reduced. In this case, turn on the VCR power.
- Even if you adjust the audio volume, audio quality, or change the DSP Program during a video recording, it has no effect on the recorded sound.
- Video recordings that you make cannot be used for any purpose other than private enjoyment without the consent of the copyright holder.
- You cannot record from a copy protected DVD disc.

Connect a game console to a digital input

If your game console has a digital output jack (optical), it can be connected to CinemaStation's OPTICAL IN jack.

See page 50, "**Connecting Audio Equipment**" to learn how to connect an optical jack.

Video output connects to CinemaStation's VIDEO IN jack.

Connect a TV to an audio input

Enjoy TV sound with CinemaStation by connecting the TV audio output jack to an AUDIO IN jack.

Press VIDEO on the Remote Control to input TV sound.

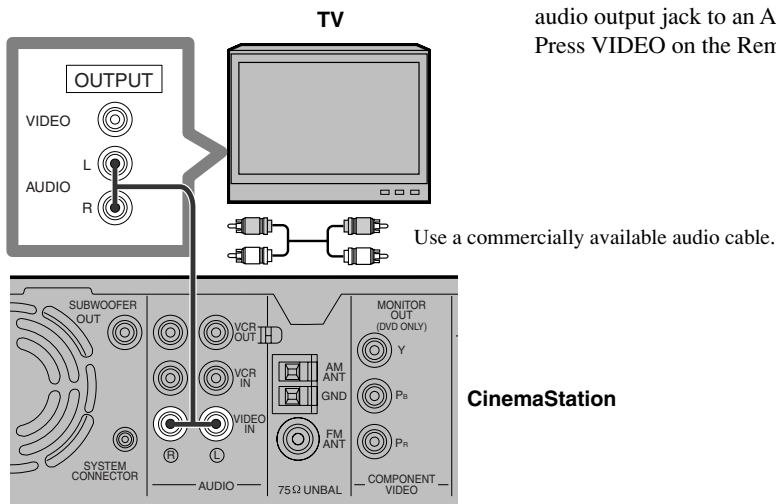

Operating a VCR

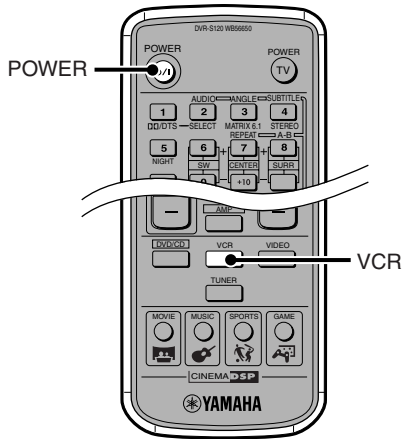

For VCR operations, read your VCR owner's manual.

Advice

- The Remote Control can also operate a television or VCR connected to CinemaStation. However, it is first necessary to enter the manufacturer code for the equipment in the Remote Control's memory. See page 83, **Storing Manufacturer Codes in the Remote Control**.

- 1 Turn on the TV.**
- 2 Turn on the VCR.**
- 3 Switch the TV input.**
For example, switch to video 1 if CinemaStation is connected to video input 1 on the television.
- 4 Press POWER to turn on CinemaStation.**
- 5 Press VCR.**
CinemaStation can now output the VCR signal.
- 6 Operate your VCR.**

Playing a Video Game or Operating a Video Camera

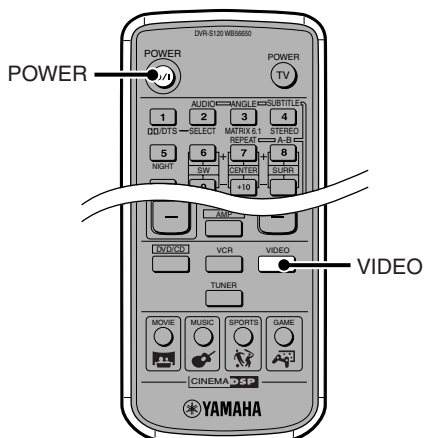

For game console and video camera operations, read their respective owner's manuals.

- 1 Turn on the TV**
- 2 Turn on a game console or video camera.**
- 3 Switch the TV input.**
For example, switch to video 1 if CinemaStation is connected to video input 1 on the television.
- 4 Press POWER to turn on CinemaStation.**
- 5 Press VIDEO.**
CinemaStation can now output video signals (game console or video camera).
- 6 Play your game console or video camera.**

Dubbing from a Video Camera to a VCR

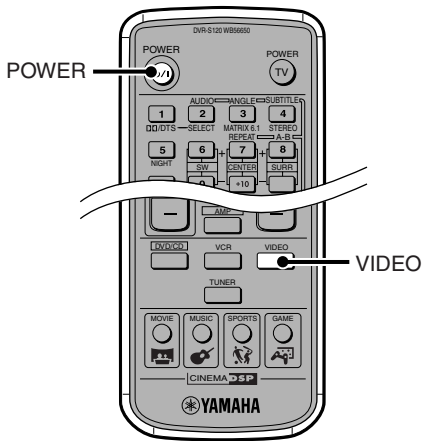

For video camera and VCR operations, be sure to read their respective owner's manuals.

- 1 Turn on the TV**
- 2 Turn on the video camera and VCR.**
- 3 Switch the TV input.**
For example, switch to video 1 if CinemaStation is connected to video input 1 on the television.
- 4 Press POWER to turn on CinemaStation.**
- 5 Press VIDEO.**
CinemaStation can now input video signal (video camera).
- 6 Prepare to record with the VCR.**
For example, switch the VCR input to external.
- 7 Start playback on the video camera, then start recording with the VCR.**

Connecting with SCART cable (U.K. and Europe models only)

Do not connect CinemaStation to a monitor via a VCR. The copyright protection technology incorporated in CinemaStation may not allow the video to play.

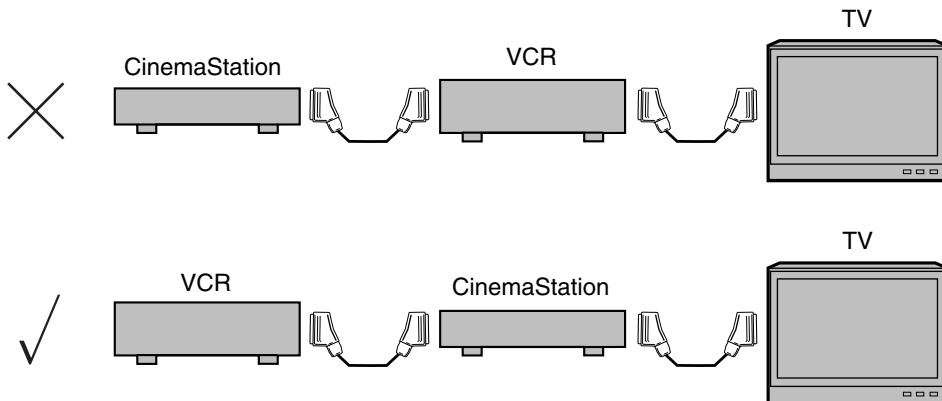

Note

- If you play a video source that uses scrambled or encoded signals to prevent it from being dubbed, the picture itself may be disturbed due to those signals.

Connecting Audio Equipment

You can connect a CD recorder or MD recorder to CinemaStation to record audio played on CinemaStation.

Connecting a CD or MD Recorder

Please...

- For equipment connection, read the owner's manual of the equipment you want to connect.

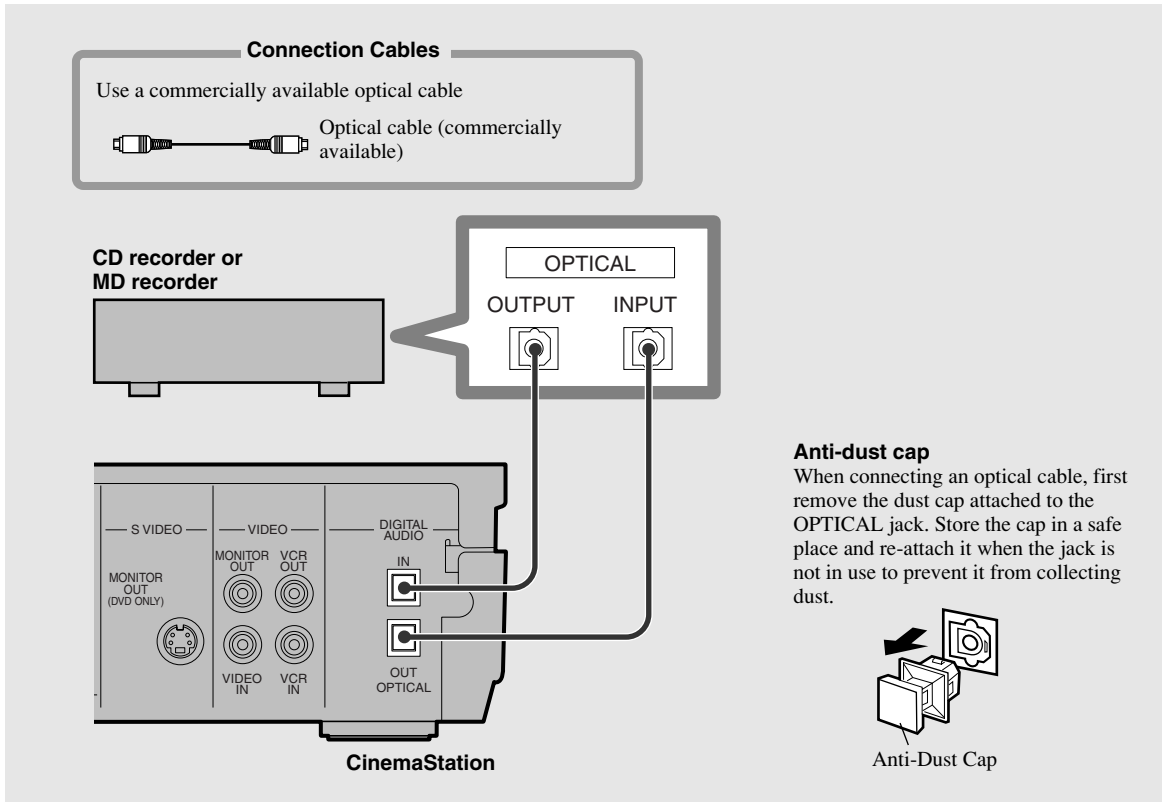

Notes on the digital audio jacks

- The digital jacks are compatible with PCM, Dolby Digital and DTS signals.
- The OPTICAL IN jack is compatible with a digital signal that has a 96 kHz or less sampling frequency.
- You can use “* Input Assign” in the SET MENU to assign VIDEO or VCR to the OPTICAL IN jack. The default setting is VIDEO.

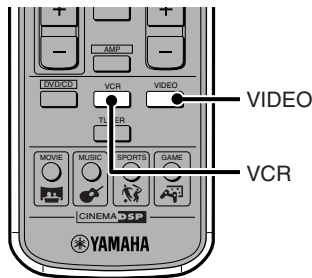

Set to VIDEO (default setting)

Press VIDEO on the Remote Control to input a signal from CD recorder or MD recorder.

Advice

- When you assign the OPTICAL IN jack as VIDEO and equipment is connected to the VIDEO IN jacks, the OPTICAL IN jack has priority over the VIDEO IN jacks if the input mode is set to AUTO.

Set to VCR

Press VCR on the Remote Control to input a signal from CD recorder or MD recorder.

Advice

- When you assign the OPTICAL IN jack as VCR and equipment is connected to the VCR IN jacks, the OPTICAL IN jack has priority over the VCR IN jacks if the input mode is set to AUTO.

For details about assigning OPTICAL IN jacks see page 88, “Using the SET MENU”. For details about input modes see page 77, “Switching Input Modes”.

- CinemaStation’s digital and analog signal circuits are independent of each other, so analog input signals can only output from analog output jacks and digital input signals can only output from digital output jacks.
- CinemaStation’s optical digital jack is designed based on EIA standards. If you use an optical cable that does not meet EIA standards, it may not function properly.

Notes on recording and playing audio

- Perform a test recording before recording.
- It is not possible to record DSP effects.
- When you turn off the connected CD recorder or MD recorder power, playback sound may become distorted and the volume reduced. In this case, turn on the CD recorder or MD recorder power.
- Even if you adjust the audio volume, audio quality, or change the DSP Program during a video recording, it has no effect on the recorded sound. However, in DVD/CD mode, the output sound for recording may cut off if any of the operations below are performed. Do not perform any of the below during recording.
 - Output a test tone.
 - Change a DSP Program
 - Connect/disconnect the headphones
- CinemaStation can output a signal from the DIGITAL IN jack to the DIGITAL OUT jack. The signal input from the DIGITAL IN jack cannot output from the analog output jacks, and the signal input from the analog input jacks cannot output from the DIGITAL OUT jacks.
- Audio recordings that you make cannot be used for any purpose other than private enjoyment without the consent of the copyright holder.

Timer Playback/Recording

Combined with a commercially available audio timer, you can perform Timer Playback and Timer Recordings. Operations vary depending on the equipment and audio timer used, so be sure to read the relevant equipment owner's manual.

Recording Audio from CinemaStation

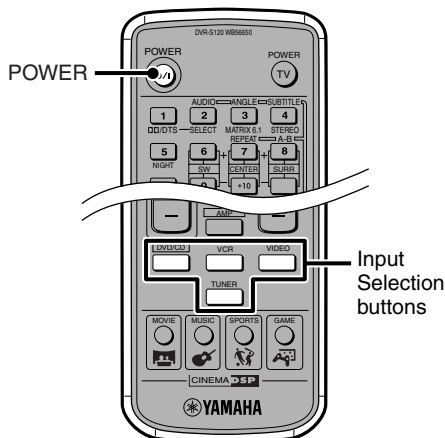

- 1 Turn on the CD recorder or MD recorder power and get ready for recording.**
- 2 Press POWER to turn on CinemaStation.**
- 3 Switch CinemaStation input to the source you want and start playback.**
Ex. To play a CD: First press DVD/CD then play the CD.
- 4 Start recording with the CD recorder or MD recorder.**

Advice

- When using Timer Playback/Recording, even if CinemaStation is in standby mode, the memory content (input source, AM/FM frequency) is retained and used.

Note

- Even if you use DTS software to digitally record a DTS signal only noise will be recorded.
- If you want to perform Timer Recording without hearing sound, turn the volume down before starting Timer Recording.

Placing the Speakers (NX-P120)

To get the most out of the sound field effects you need to place the speakers in the best positions. To guard against poor acoustics like sound blur make sure the speakers are stable. Also read page 7, **Preparing the Speakers**.

Placing the Center Speaker

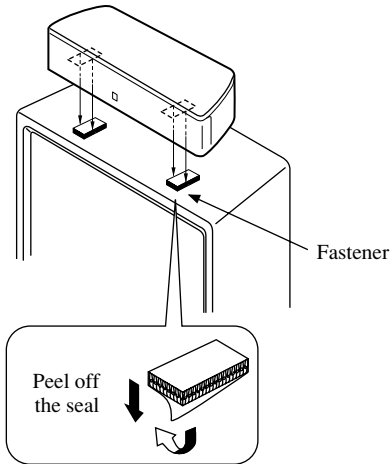

Make sure the top of the television is level. If the top of the television is not level, place the Center Speaker inside the TV rack or directly on the floor. In any case, make sure it is placed on a level surface.

When placing on top of the television, use the supplied fastener (two pieces) as shown in the picture on the left, between the bottom of the Center Speaker and top of the television to fasten.

Note

- Do not place on a television with top narrower than the bottom of the speaker. You may get injured if the speaker falls over.
- Do not place if the top of the television is slanting. You may get injured if the speaker falls over.
- After peeling off the fastener seal, do not touch the bonding surface. If you do, the bonding surface weakens, which later may cause the speaker to fall over.
- Before attaching the fastener to the television, wipe the TV top clean. If the surface is dirty or wet tape will lose bonding strength, which later may cause the speaker to fall over.

Placing the Subwoofer

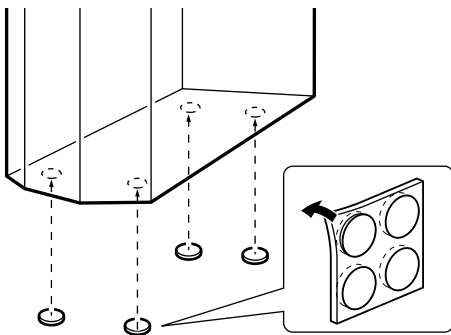

Place the Subwoofer on a level hard floor.

When placing, use non-skid pads on the bottom of the Subwoofer in the four corners as shown in the picture. This will prevent the Subwoofer from sliding when it vibrates. Also, increasing stability prevents degradation of sound.

Placing the Front and Surround Speakers

You can place the Front Speakers and Surround Speakers on the floor or a rack, or attach them to a wall. You can also mount them on commercially available speaker stands.

When placing on the floor or a rack

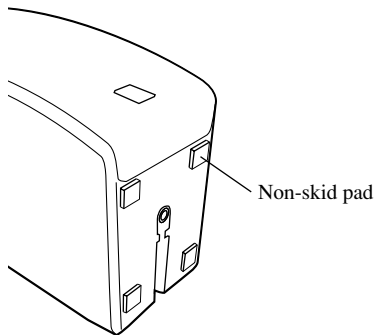

As shown in the picture, attach the non-skid pads on the bottoms of the Front and Surround Speakers in the four corners. This stabilizes the speakers to prevent sliding.

* Place on a stable, flat surface.

When attaching to a wall

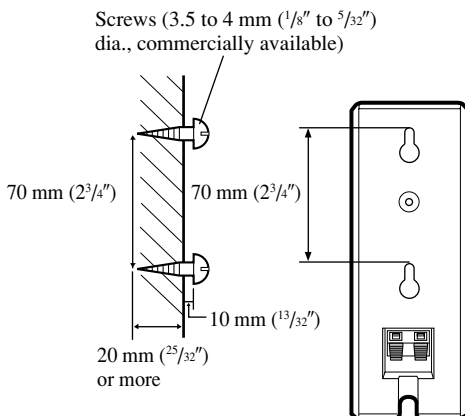

Attach to the wall using the two holes on the back of the Front and Surround Speakers.

1 Attach 2 screws (3.5 to 4 mm (1/8" to 5/32") dia., commercially available) to each place you want to hang a Front or Surround Speaker.

2 Hang the speakers on the screws using the holes in the back of each speaker.

Note

- Make sure that the tapping screw enters the narrow part of the hole and the speaker is fixed securely in place.

Note

- One speaker weighs about 1.1 kg (2.43 lb). Make sure you fasten screws only into a solid wall or pillar. Do not attach to a wall that is made of plaster, decorative veneer sheeting or other material that peels easily. If the screws come off and a speaker falls, somebody may get injured.
- Do not attach the speakers using nails or two-sided tape. Vibration during use may cause the nails to loosen, tape to peel off and speakers to fall, resulting in injury.
- CinemaStation may fall over if your feet or hands get caught in the speaker cable. Make sure the cables are fixed in place.
- After attaching everything, check the overall safety of your installation.
YAMAHA will bear no responsibility for accidents caused by improperly placed equipment or faulty installation methods.

When attaching to a speaker stand and bracket

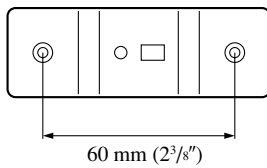
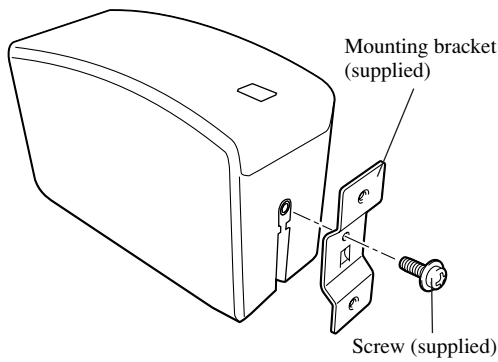

1 Use the supplied screw to attach the mounting bracket to the bottom of the speaker.

The jutting part of the bracket enters the groove at the speaker base.

2 Use the bracket holes (60 mm (2³/₈") spacing) to fasten the mounting bracket to the speaker stand.

Use the screws (4 mm (5/32") dia.), spring washers and washers.

Advice

- When attaching to a speaker stand and bracket, be sure to read their respective owner's manuals.
- When attaching to the optional SPS-80 Speaker Stands, you do not need to attach the supplied mounting brackets.

Yamaha Speaker Stand SPS-80 (Option)

With the SPS-80 Speaker Stands, you can set the Front Speakers and Surround Speakers on the floor. (2 stands/set)

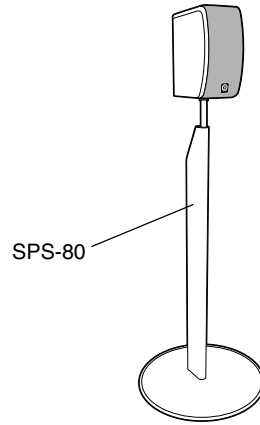

* SPS-80 stands may not be available in certain regions.

Using Commercially Available Speakers or Cables

You can use commercially available speakers instead of the supplied Center Speaker, Front Speakers, Surround Speakers, or Subwoofer. You can also use commercially available speaker cables instead of the supplied cables.

Note

- Use a speaker with 6-ohm impedance or more. If a speaker with less than 6-ohm impedance is used, the protective circuit may trip or the speaker may malfunction.
- Use magnetically shielded speakers. If these speakers still create interference with the monitor, place the speakers away from the monitor.
- Make sure the speaker cable you use is the same thickness as the supplied cable.

Advice

- Use speakers of the same manufacturer and quality, if possible. If the quality of each speaker differs, the voice of a moving person may become unnatural.

Changing the speaker cables

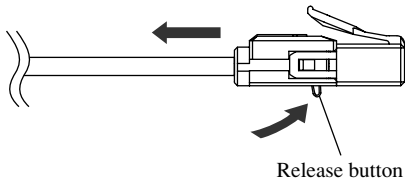

- 1 Push up the release button and pull out the supplied speaker cable from the connector.**

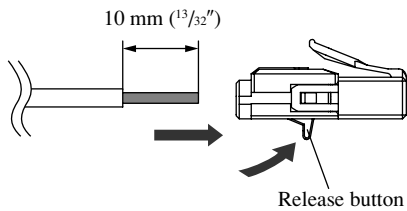

- 2 Peel away about 10 mm ($13/32''$) of covering from the tip of the commercially available cable and firmly twist the cable cores.**
Not twisting firmly can cause a short.

- 3 Keep pushing up the release button and insert the cable cores of the commercially available cable.**
Match the speaker cable polarity (+/-) with the polarity indicator (+/-) of the connector.

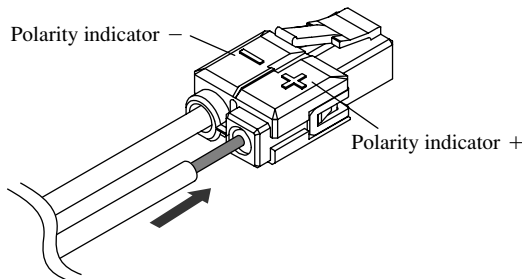

- 4 Release your finger from the release button to fasten the cable.**

Adjusting the Speaker Volume Level

The default settings of the Speakers are suitable for most conditions. However, depending on room conditions or listening position, you may need to adjust the Speaker volume level, especially when changing speaker or furniture position.

This adjustment is important because it brings out the maximum effect of the DSP Program, and faithfully reproduces the acoustic personalities of Dolby Pro Logic, Dolby Pro Logic II, Dolby Digital and DTS.

Even after performing the test tone, you may still like to adjust the speaker volume level for some sources. In this case see page 60, “Adjusting the Speaker Volume Level During Playback”.

Note

- You cannot adjust the volume level while connected to headphones. To adjust, disconnect your headphones.

Adjusting the Speaker Balance with a Test Tone

Adjust the volume so that it is the same for each speaker from your listening position.

Note

- To adjust the sound, use the Remote Control from your listening position.

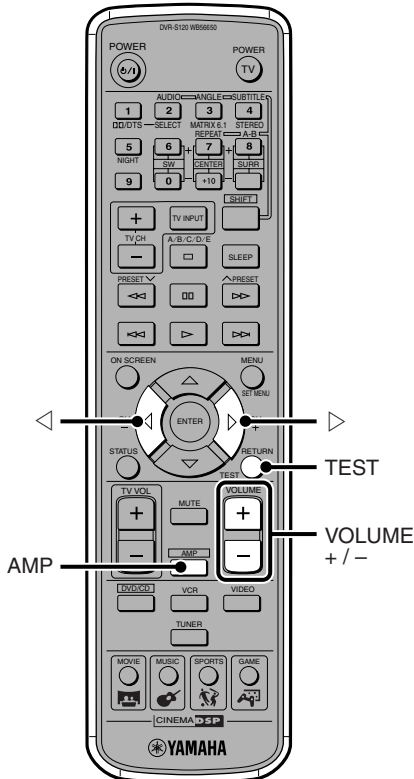

1 Press AMP.

2 Press TEST.

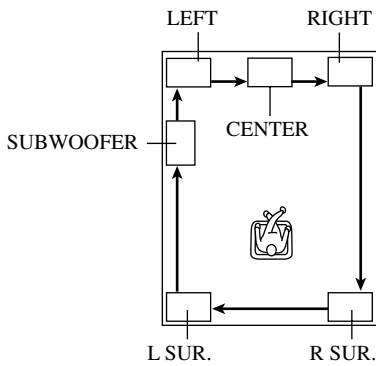

3 Adjust the overall sound using the VOLUME +/- so that you can hear the test tone.

The picture on the left shows the test tone order: LEFT (Front L Speaker) → CENTER (Center Speaker) → RIGHT (Front R Speaker) → R SUR. (Surround R Speaker) → L SUR. (Surround L Speaker) → SUBWOOFER (Subwoofer). Each speaker outputs sound for about 2 seconds. The speaker currently outputting a test tone appears in the CinemaStation Display.

4 While a test tone is outputting from the speaker you want to adjust, press ◀ or ▶ and tune it to the same volume level as the Front Speakers.

Only the speaker currently being adjusted produces a test tone.

Note

- While in test tone mode you cannot adjust the volume level of the Front Speakers which serve as the standard. If you need to adjust the volume level of the Front Speakers, press VOLUME +/-.

5 When adjustment is finished, press TEST.

The test tone stops.

Advice

- If you raise the volume level of the Center and Surround L/R Speakers to + 10 dB and this is still less than the Front Speakers, set the “* F. Level” in the SET MENU to -10 dB and lower the volume level of the Front Speakers by about 1/3. If you change the volume level of the Front Speakers, adjust the volume level of the Center and Surround L/R Speakers once again.

Note

- If “* CENTER” in the SET MENU is set to “NON”, the Center Speaker signal is distributed to the Front L/R Speakers at the same volume level and output. In this case, you cannot adjust the audio output level of the Center Speaker.
- If “* SUR” in the SET MENU is set to “NON”, you cannot adjust the volume level of the Surround L/R Speakers. The test tone skips the Surround L/R Speakers and continues its cycle.
- If “* BASS” in the SET MENU is set to “FRONT”, the test tone skips the Subwoofer and continues its cycle.
- The test tone for Subwoofer is different from the others, but this is not a defect.

Adjusting the Speaker Volume Level During Playback

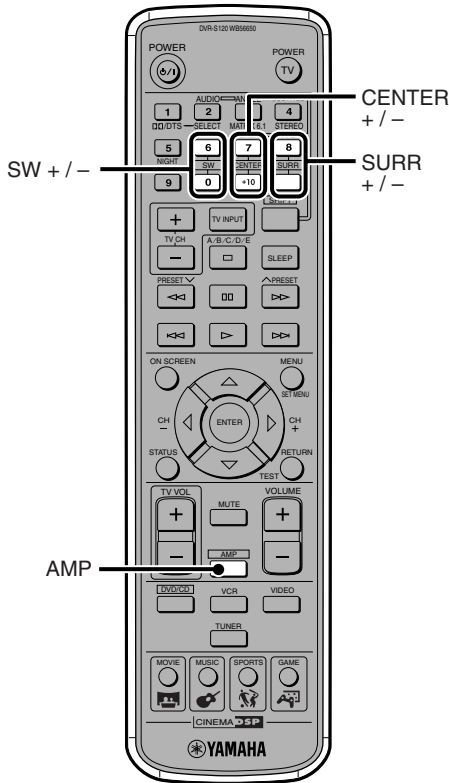

Adjust the volume level of the Subwoofer, Center and Surround Left/Right Speakers, if you feel the speaker is unbalanced during audio playback.

Advice

- Volume levels other than for Front Speakers can be adjusted.

1 Press AMP during playback.

- ### 2 Adjust the speaker volume level.
- To adjust the Subwoofer volume press SW +/-.
 - To adjust the Center Speaker volume press CENTER +/-.
 - To adjust the Surround Speakers volume press SURR +/-.

Advice

- The volume level adjustment range is +10 dB to -10 dB.
- You cannot adjust the Left and Right Surround Speakers individually. The same adjustment level will be applied to both. If the level adjusted during the sound test was different for Left and Right and one speaker was then tuned to a maximum of +10 dB or a minimum of -10 dB, the value cannot be adjusted any further up or down.
- We recommend that you first adjust the speaker balance with a test tone. See page 58, “Adjusting the Speaker Balance with a Test Tone”.
- If you change the speaker volume level with the SW, CENTER or SURR buttons, the levels you adjust with the test tone also change.

Note

- Depending on your settings in SET MENU, volume level adjustment may not be available for a speaker.
 - If “* CENTER” is set to “NON” you cannot adjust the Center Speaker.
 - If “* SUR.” is set to “NON” you cannot adjust the Surround Speakers.
 - If “* BASS” is set to “FRONT” you cannot adjust the Subwoofer.

Adjust speaker volume for 5ch Stereo DSP Program

You can adjust the speaker volume for 5ch Stereo DSP Program

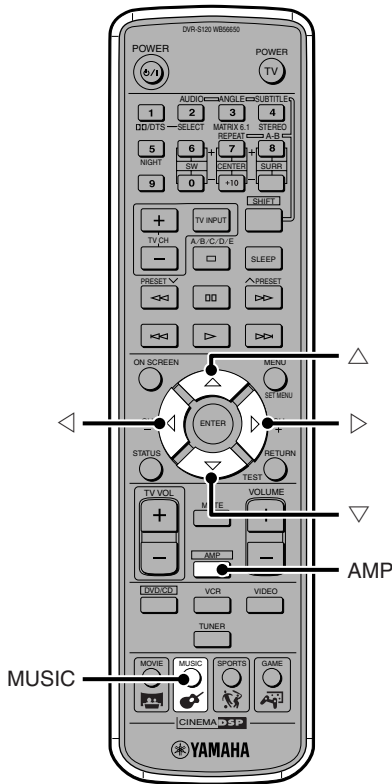

- 1 Press AMP during playback.**
- 2 Repeatedly press MUSIC and select "5ch Stereo".**
- 3 Repeatedly press ∇ or \triangle , and select the speaker you want to adjust.**
 The switching order is CT LEV \rightarrow RL LEV \rightarrow RR LEV \rightarrow CT LEV...
To adjust the Center Speaker volume level, select CT LEV.
To adjust the Surround L Speaker volume level, select RL LEV.
To adjust the Surround R Speaker volume level, select RR LEV.
- 4 Press \triangleleft or \triangleright and adjust the speaker volume level.**
 When setting to 50%, the speaker volume becomes half, and when setting to 0%, you hear no sound from the Speaker.

Creating the Best Listening Space

Advice

You can adjust the speaker volume level from 0 to 100%. The factory default setting is 100%, which is the maximum value.

Note

- The volume levels adjusted with the test tone or the CENTER or SURR buttons in 5ch Stereo mode are replaced with the setting with "CT LEV", "RL LEV" or "RR LEV". The actual volume you hear is the volume shown in the CinemaStation Display multiplied by the percentage you set for volume level.
- If "** CENTER" is set to "NON", you cannot adjust the Center Speaker. If "** SUR." is set to "NON", you cannot adjust the Surround Speakers.

English

Setting the Speaker Size

To get the most out of the sound field effects, you need to use all 6 of the supplied speakers (Front, Center, Surround and Subwoofer). But depending on your listening objectives, you can turn off specified speakers.

When using any speaker other than YAMAHA Speaker Set NX-P120, you need to specify the speaker size.

You can specify these settings in Speaker mode.

Setting the Speaker Mode

Specify the speaker to produce no sound by setting “* CENTER”, “* SUR.” or “* BASS”.

When using other speakers, be sure to set the speaker size, and depending on your listening objectives set the Front Speaker level.

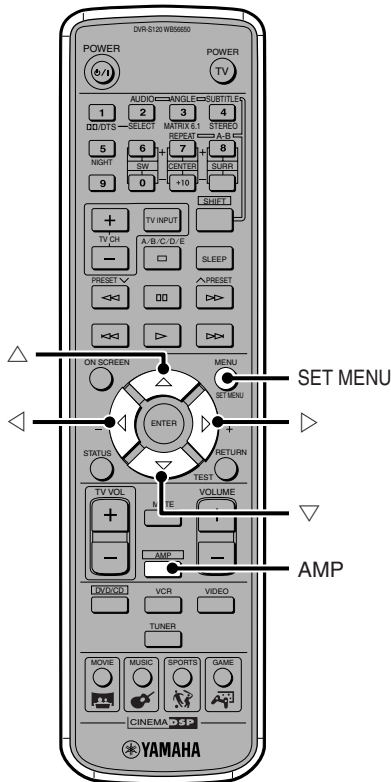

- 1 Press AMP.
- 2 Press SET MENU. “* Speaker Set” appears.
- 3 Press \blacktriangleright .
- 4 Press \blacktriangle or \blacktriangledown to select item you want to set.
- 5 Press \blacktriangleleft or \blacktriangleright to change the setting.
- 6 Repeat steps 4 and 5 to set the needed item.
- 7 When exiting the SET MENU, press SET MENU. Pressing any one of the DSP Program buttons also exits the SET MENU.

Advice

- Even if “* FRONT” is set to “SMALL”, when “* BASS” is set to “FRONT”, low tones below 90 Hz of the Front L/R channel signal will output from the Front Speakers.
- If you select a sound field effect when “* SUR.” is set to “NON”, CinemaStation enters Virtual Cinema DSP mode.
- Settings made in Speaker mode are not reflected when connected to headphones.

Note

- When a sampling digital signal over 48 kHz is input, some settings may not be reflected in the playback sound.

*** CENTER**

Sets whether the Center Speaker is present or not, and sets the size of the Center Speaker.

Selection items: LRG (Large), SML (Small), NON (None)

Default setting: SML

LRG: Select this setting when using a big Center Speaker. The entire frequency band of the center channel signal is output as it is from the Center Speaker.

SML: Select this setting when using a small Center Speaker. A center channel signal with a low tone of 90 Hz or below is output from the speaker set to * BASS.

NON: Select this setting when not using a Center Speaker. The center channel signal distributes the same volume level to the Front L/R Speakers.

*** FRONT**

Sets the size of the Front Speakers.

Selection items: LARGE, SMALL

Default setting: SMALL

LARGE: Select this setting when using big Front Speakers. The entire frequency band of the front L/R channel signal is output as it is from the Front Left and Right Speakers.

SMALL: Select this setting when using small Front Speakers. A front L/R channel signal with a low tone of 90 Hz or below is output from the speaker set to * BASS.

*** SUR.**

Sets whether the Surround L/R Speakers are present or not, and sets the size of the Surround L/R Speakers.

Selection items: LRG (Large), SML (Small), NON (None)

Default setting: SML

LRG: Select this setting when using big Surround L/R Speakers or when using Surround L/R Speakers with surround subwoofers connected by speaker cables. The entire frequency band of the surround L/R channel signal is output as it is from the Surround Speakers.

SML: Select this setting when using small Surround L/R Speakers. A surround L/R channel signal with a low tone of 90 Hz or below is output from the speaker set to * BASS.

NON: Select this setting when not using Surround L/R Speakers. The surround L/R channel signal distributes the same volume level to the Front L/R Speakers.

*** BASS**

Selects the speaker to output a LFE/BASS (low tone) signal. LFE stands for Low Frequency Effect and it is used to output bands of 90 Hz and below when Dolby Digital or DTS is active.

Selection item: SWFR (Subwoofer), FRONT, BOTH

Default setting: SWFR

SWFR: Select this setting when using a Subwoofer. The LFE and low tone (90 Hz and below) sound from other channels, depending on * CENTER, * FRONT and * SUR. settings, are output from the Subwoofer.

FRONT: Select this setting when not using a Subwoofer. The LFE and low tone (90 Hz and below) sound from other channels, depending on * CENTER, * FRONT and * SUR. settings, are output from the Front L/R Speakers.

BOTH: Select this item to mix a low tone of 90 Hz and below with a LFE channel when using a Subwoofer and independent of the Front Speaker Sound mode setting. The entire frequency band of the front L/R channel is output from both the Front L/R Speakers and Subwoofer. Sound can output from the Subwoofer during 2-channel or Dolby Surround playback.

*** F. Level**

Selects the Front Speaker level.

When the Front Speaker volume level is extremely high and out of alignment with that of other speakers, you can lower the volume level and regain a balance.

Selection items: Nrm (Normal), -10 dB

Default setting: Nrm

Nrm: Usually this setting is selected.

-10 dB: Use this setting if the output level of the Center or Surround Speakers is out of alignment with the Front Speakers. The volume level of the Front Speakers decreases 10 dB (about 1/3).

Selecting DSP Program Effects

To get the most out of CinemaStation, select a sound field based on how many speakers you want to use and the listening environment.

Select a sound field based on how many speakers you want to have sound.

- For a 6-speaker plus surround back speaker setup, see page 64, “Using Matrix 6.1”.
- For a 6-speaker setup, see page 66, “Using All Speakers for CD or Video playback”.
- For a 2-speaker setup, see page 68, “Using Front Speakers Only for DSP Program (Virtual Cinema DSP)”.

Select a sound field based on your listening environment

- For headphones, see page 69, “Using a DSP Program with Headphones (SILENT CINEMA)”.
- For evening enjoyment, see page 70, “Using a DSP Program with Low Volume (Night Listening)”.
- For setting a DSP Program to match your listening room, see page 71, “Changing the Delay Time of a DSP Program”.

Enjoy original Dolby and DTS sound

- To listen to original Dolby or DTS sound as it is, see page 73, “Reproducing the Original Dolby and DTS Sound”.
- To listen to stereo sound as it is, see page 74, “Enjoying Stereo Sound”.

Using Matrix 6.1

Matrix 6.1 sound creates a realistic sense of sonic movement with a surround back sound.

You can enjoy Dolby Digital plus Matrix 6.1 or DTS plus Matrix 6.1 sound without adjusting any settings when you play a Dolby Digital Surround EX or DTS ES disc.

In addition to Dolby Digital Surround EX or DTS ES discs, you can also enjoy Matrix 6.1 sound with a 5.1 channel source. Selecting Matrix 6.1 with the MATRIX 6.1 button will enable the Dolby Digital plus Matrix 6.1 and DTS plus Matrix 6.1 decoder. The surround L/R channel will produce a surround back channel, making it possible to output sound from a virtual surround back speaker.

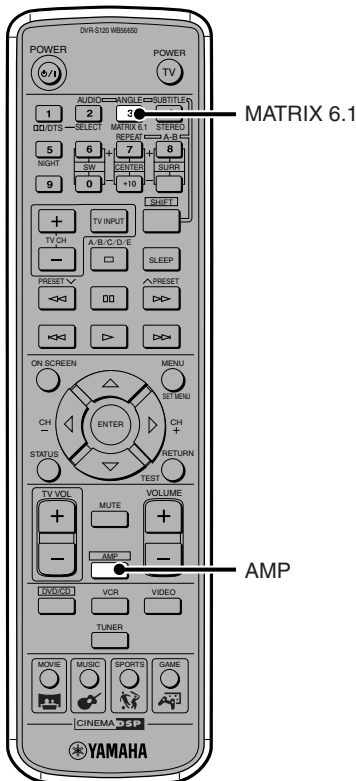

1 Press AMP.

2 Press MATRIX 6.1 to set.
The display indicator switches in the following order each time you press MATRIX 6.1 : AUTO (auto-recognition) → Matrix 6.1 (Matrix audio) → OFF → AUTO...

- AUTO:** Depending on whether the source is Dolby or DTS, automatically switches between Dolby Digital plus Matrix 6.1 and DTS plus Matrix 6.1 audio. Even if you play a 5.1 channel source with this setting, no virtual surround back speaker is created.
- MATRIX 6.1:** Select this item to play a 5.1 channel source with Matrix 6.1. Sound outputs from the virtual surround back speaker.
- OFF:** The Matrix 6.1 decoder is not enabled. Even if you play a Dolby Digital Surround EX or DTS ES disc, no sound outputs from the virtual surround back speaker.

 **Advice**

- When the Matrix 6.1 decoder is working, the MATRIX indicator lights up in the CinemaStation Display. 6.1 appears beside the DSP Program name (For example: Action 6.1). Matrix 6.1 appears with Dolby Digital and DTS sound fields.

 **Note**

- Some Dolby Digital Surround EX or DTS ES discs do not contain a signal (flag) that CinemaStation can use for auto recognition. To play this type of disc with 6.1-channel sound, press MATRIX 6.1 to select Matrix 6.1.
- In the cases below, 6.1-channel sound cannot play even if you press MATRIX 6.1.
 - If “* SUR.” is set to “NON” in the SET MENU.
 - If sound effect is set to off (Stereo Playback).
 - If headphones are connected.
 - If a Dolby Digital KARAOKE source is playing.
 - If you select 5ch Stereo DSP Program.
- If you turn on the power once more after CinemaStation goes into standby, Matrix 6.1 returns to AUTO.

Using All Speakers for CD or Video playback

Selecting Dolby Pro Logic II converts a 2-channel source into virtual multi-channels for enjoying sound using all speakers.

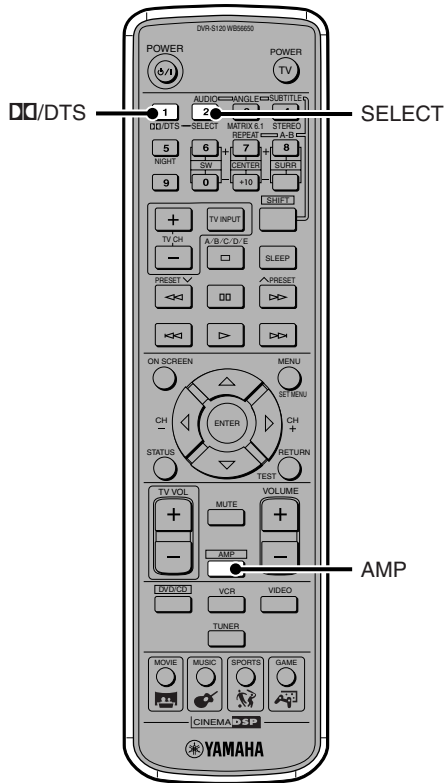

- 1 **Play the 2-channel source.**
- 2 **Press AMP.**
- 3 **Press DDD/DTS.**
- 4 **Press SELECT repeatedly to select "PRO LOGIC II".**
- 5 **Press DDD/DTS to select "PRO LOGIC II Movie" or "PRO LOGIC II Music".**
Each time the button is pressed the selection switches between "PRO LOGIC II Movie" and "PRO LOGIC II Music". Match your source with the appropriate selection item, Movie or Music.

Advice

- You can also press the DSP button on CinemaStation to select "PRO LOGIC II Movie" or "PRO LOGIC II Music".

Note

- Even if you play back a monaural source with Dolby Pro Logic II, CinemaStation cannot reproduce multi-channel sound.

Change the Dolby Pro Logic II Music setting

You can change the settings (parameters) for Dolby Pro Logic II Music and adjust the sound field to match your listening space.

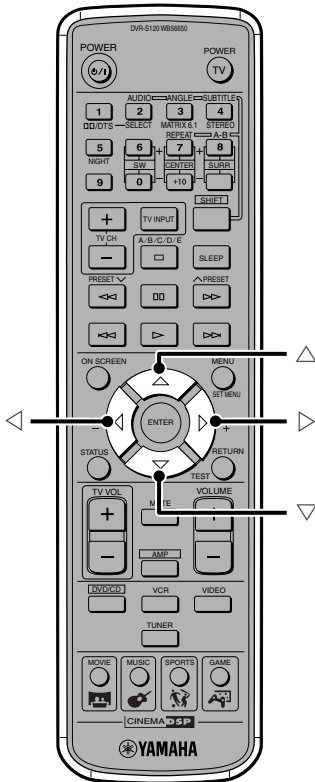

- 1 Perform steps 1 to 5 in “Using All Speakers for CD or Video playback” on page 66, and select “PRO LOGIC II Music”.
- 2 Press Δ or ∇ repeatedly to select “PANORAMA”, “DIM.” or “CT WIDTH”.
- 3 Press \triangleleft or \triangleright to change the setting value.
- 4 Repeat steps 2 and 3 if you want to change other setting values.

Below are the “Pro Logic II Music” setting values (parameters).

PANORAMA

Gives front L/R channel sound a wraparound effect, distributed throughout the entire surround sound field, for an expansive feeling.

Function: Expands the front sound field of Dolby Pro Logic II.

Selection item: OFF/ON

Default setting: OFF

DIM. (Dimension)

Adjusts the difference in volume between front and surround channels to the volume balance you desire.

Function: Adjusts the difference between front surround sound field and surround volume.

Variable range: -3 (stronger toward the surround direction) to +3 (stronger toward the front direction).

Default setting: STD (Standard)

CT WIDTH

Distributes the center channel sound to the left and right.

Function: Expands audio from the front sound field to the left and right.

Variable range: 0 to 7.

If set to 0 center channel sound will only output from Center Speaker. As the value rises center channel sound is incrementally distributed to the L/R Speakers. When set to 7, sound will only output from the L/R Speakers.

Default setting: 3

Using Front Speakers Only for DSP Program (Virtual Cinema DSP)

Since Virtual Cinema DSP processes the sound input source, you can virtually reproduce surround speakers, and enjoy a DSP Program with only your Front L/R Speakers.

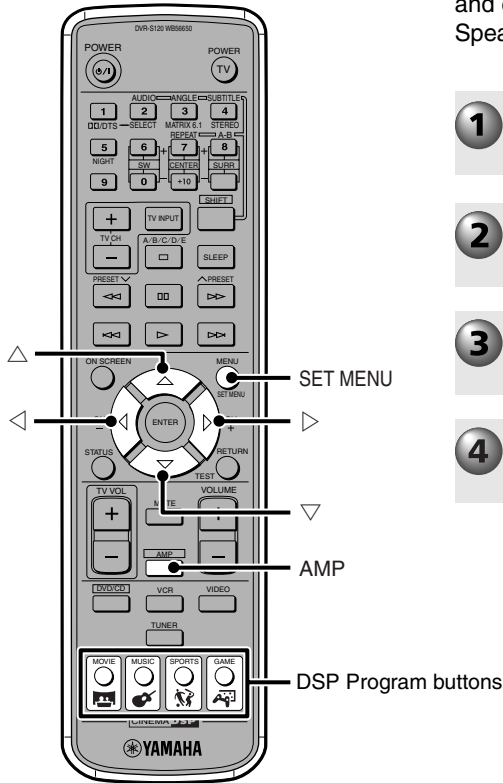

- 1 Play the source.
- 2 Press AMP.
- 3 Select a DSP Program.
- 4 Set “* SUR.” to “NON” in the SET MENU. See page 62, “Setting the Speaker Mode”.

Advice

- For Virtual Cinema DSP, the VIRTUAL indicator lights up in the CinemaStation Display.

Note

In the cases below, even if “* SUR.” is set to “NON” in the SET MENU, Virtual Cinema DSP does not function.

- When you select the following DSP Programs: Sch Stereo; PL Normal; Dolby Digital or DTS Normal; PL II Movie or PL II Music.
- When sound field effects are off (Stereo Playback).
- When a digital audio sampling frequency over 48 kHz is input.
- When using a test tone.
- When listening through headphones.

Using a DSP Program with Headphones (SILENT CINEMA)

Connect your headphones to the  (phones) jack on CinemaStation and enjoy multi-speaker simulation called SILENT CINEMA.

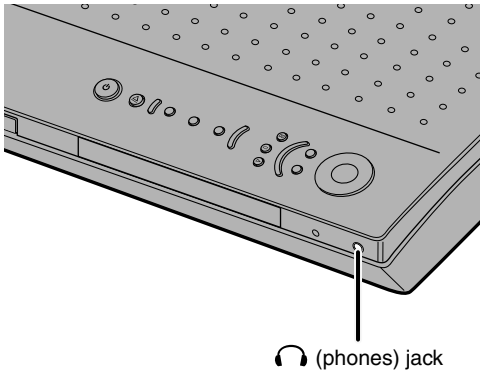

 (phones) jack

1 Connect your headphones to the  (phones) jack on CinemaStation.

2 Play the source.

3 Select a DSP Program.

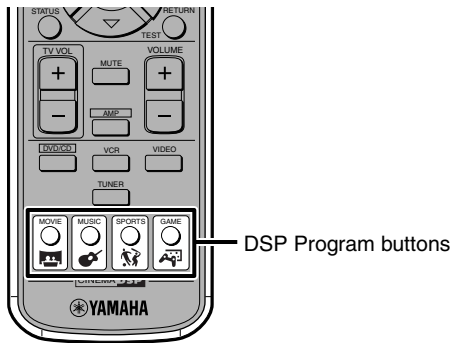

DSP Program buttons

Advice

- When SILENT CINEMA is on, the SILENT CINEMA indicator lights up in the CinemaStation Display.
- CinemaStation mixes LFE channel audio and other channel audio.
- When headphones are connected, sound does not output from any speaker regardless of whether sound field effect is on or off.
- When you do not select any DSP Program, the headphone produces normal stereo sound.

Note

- If CinemaStation inputs a digital audio sampling frequency over 48 kHz, SILENT CINEMA does not function.

Using a DSP Program with Low Volume (Night Listening)

You can control the big sound effects and focus on listening clearly to speech. Enjoy a DSP Program even in the evening at a low volume.

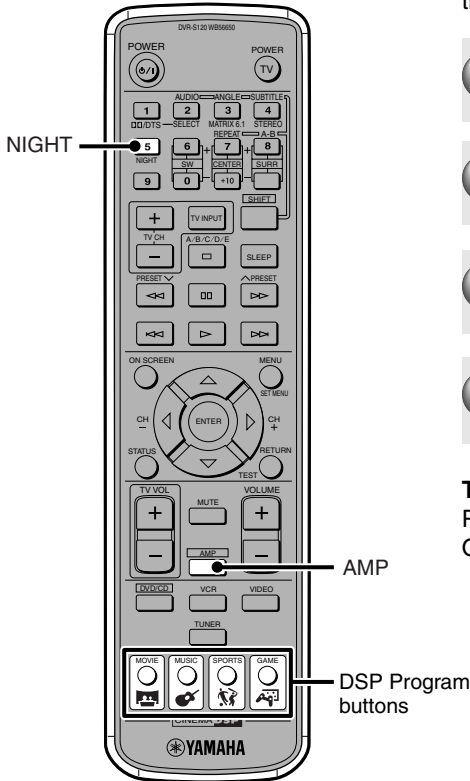

- 1 **Play the source.**
- 2 **Press AMP.**
- 3 **Select a DSP Program.**
- 4 **Press NIGHT to activate Night Listening mode.**
“Night L. ON” appears in the CinemaStation Display.

To return to normal play

Press NIGHT to deactivate Night Listening mode. “Night L. OFF” appears in the CinemaStation Display.

Advice

- All DSP Programs are available in Night Listening mode.
- Night Listening mode does not work when listening through headphones.

Changing the Delay Time of a DSP Program

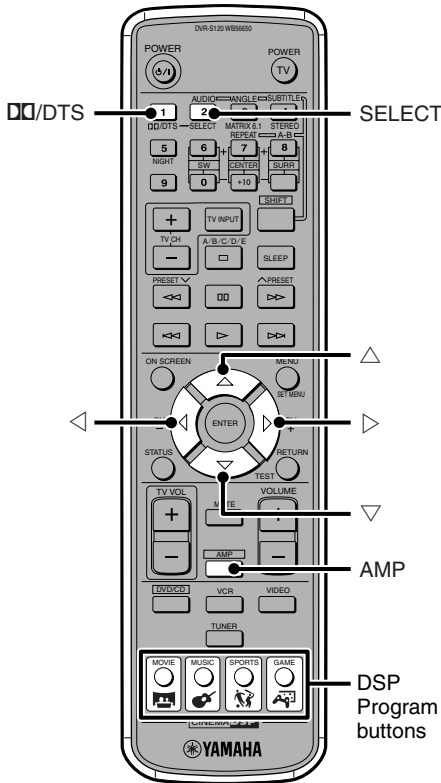

Each DSP Program is designed to draw out the maximum effect from the source audio. CinemaStation provides the DSP Programs with optimum value of parameters including reflected sound, reverberant sound and Delay Time.

Among these parameters, you can change the Delay Time to match to your Speaker positions.

Delay Time is the time gap in playback between front speaker audio and surround speaker audio. The bigger the value becomes the later the surround audio plays back, and the bigger the sound space feels.

Delay Time is preset at an optimum value for each DSP Program. In most cases, the default value will work well for your listening enjoyment. But depending on the audio source or listening environment, you can adjust each DSP Program the way you like.

1 Play the source.

2 Press AMP.

3 Select a DSP Program.

To select a Movie, Music, Sports, or Game DSP Program, press the appropriate DSP Program button (MOVIE, MUSIC, SPORTS or GAME).

To select a Dolby Digital, Dolby Pro Logic or DTS, after pressing DOLBY/DTS, repeatedly press SELECT until you come to the item you want.

4 Press Δ or ▽.

The DELAY indicator appears in the CinemaStation Display.

5 Press ◀ or ▶ to adjust the Delay Time.





Advice

- You can also adjust the Delay Time of Matrix 6.1 DSP Program.

Note

- Depending on the source it is possible to over or under adjust the Delay Time and create an unnatural sound effect.
- While adjusting the Delay Time, you hear no sound temporarily.

Default values for Delay Time

Program Group		Program Name	Default Setting (ms)
 MOVIE	1	Action	20
		Action 6.1	15
	2	Drama	20
		Drama 6.1	15
	3	Sci-Fi	20
		Sci-Fi 6.1	15
	4	Spectacle	23
		Spectacle 6.1	15
	5	Theater	20
		Theater 6.1	5
 MUSIC	1	Music Video	21
	2	Classic Hall	30
	3	Jazz Club	30
	4	Rock Concert	15
 SPORTS	1	Live Sports	10
 GAME	1	Game	36

Dolby Digital, Dolby Pro Logic and DTS

Program Name	Default Setting (ms)
PL Normal (Dolby Pro Logic)	15
Normal (Dolby Digital, DTS)	5
Matrix 6.1 (Dolby Digital, DTS)	5
PL II Movie (Dolby Pro Logic II Movie)	15
PL II Music (Dolby Pro Logic II Music)	5

Reproducing the Original Dolby and DTS Sound

You can play back and enjoy movie sound processed with Dolby Digital, Dolby Pro Logic or DTS. Enjoy smooth, precise and flowing audio of the original sound design.

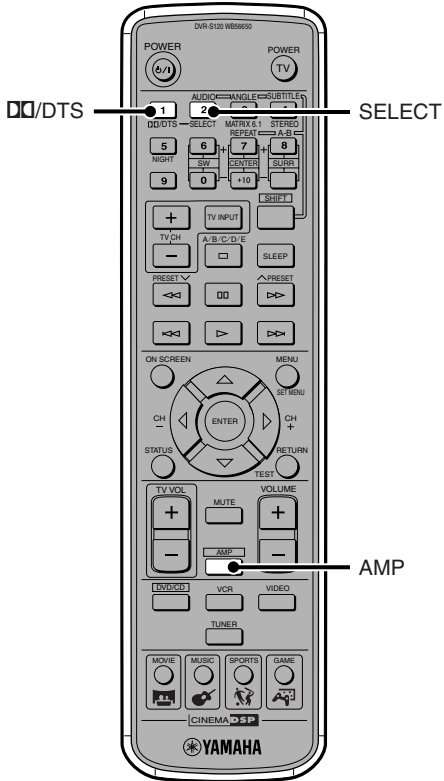

1 Play the source.

2 Press AMP.

3 Press **Dolby/DTS.**

The suitable Program is selected depending on the input source.

Dolby Digital: Normal appears, and **Dolby** indicator lights up.
 DTS: Normal appears, and **dts** indicator lights up.
 When the 2-channel source (Dolby Pro Logic II) is selected, press SELECT to select PL Normal.

Reproducing Stereo Sound

You can enjoy the 2-channel (stereo sound) source only with the Front L/R Speakers.

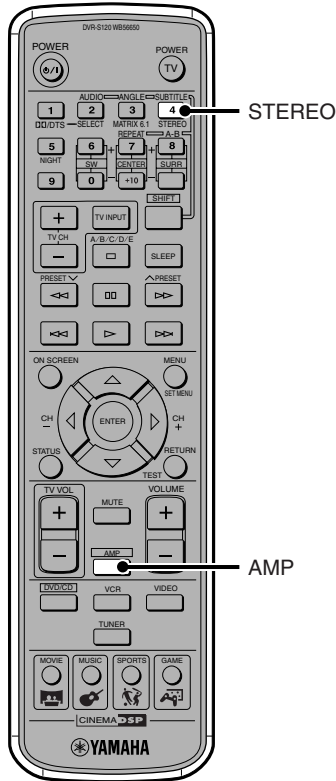

1 Play the source.

2 Press AMP.

3 Press STEREO. The STEREO indicator lights up in the CinemaStation Display. If sound field effects are off, you will have normal stereo playback. Press STEREO once more to turn on the sound field effect.

Advice

- An LFE channel can be output from the Front L/R Speakers or Subwoofer depending on how you set “* BASS” in the SET MENU.
- If “* BASS” in the SET MENU is set to “BOTH” or “* FRONT” is set to “SML”, a low tone is output from the Subwoofer.

Note

- If sound field effects are off, no sound will output from the Center Speaker or Surround L/R Speakers.
- The volume may become very low if you turn off sound field effects and set “* D. Range” to “MIN” in the SET MENU. In this case, turn on sound field effects.
- If sound field effects are off and you play Dolby Digital or DTS audio, the volume balance of the Front L/R Speakers may be disturbed. This is because the dynamic range becomes compressed and the channel sound set in “* Speaker Set” in the SET MENU mixes and outputs with the front L/R channel sound.

Types of Input Signals

You can check the type of input signal and format from the CinemaStation Display.

You can also set the input mode to select the digital/analog entry sequence or to only input a specified signal.

Checking Sound Information (Input Signal Information Display)

During playback, you can show input signal type, format and sampling frequency information in the CinemaStation Display.

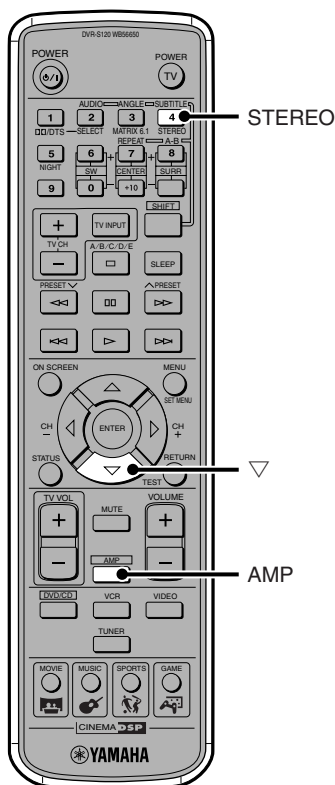

1 Play the source.

2 Press AMP.

3 Press STEREO.
Stereo playback begins.

4 Press ▽.
Input signal information appears.
Depending on the input source, input signal information changes each time you press ▽.

Input signal information

■ (Format)

Shows the input signal format. When the digital input cannot be recognized, the mode is set to analog.

Input Signal	Format Display
Analog Audio	Analog
PCM Audio	PCM
Dolby Digital Audio	Dolby DGTL
DTS Audio	DTS
Other Digital Signals	Unknwn DGTL

■ (Audio Channels)

Shows the number of audio channels an input signal contains (only when Dolby Digital or DTS is input). For example, “in: 3/2/LFE” indicates 3 Front Channels, 2 Surround Channels and LFE.

“1+1” indicates Main + Sub in bilingual broadcasts or other 2 channel audio, and MLT indicates 3-channel or more multi-channel audio.

■ fs

Shows the frequency sampling of an input signal (only when digital signal is input). If the sampling frequency cannot be measured, “unknown” appears.

■ rate (bit rate)

Shows the amount of data an input signal contains per second (only Dolby Digital and DTS). If the bit rate cannot be measured, “unknown” appears.

■ flg (flag)

Shows a recognition signal (flag), in an input signal and initiates an action (only Dolby Digital and DTS). If the flag cannot be recognized, “None” appears.

Note on digital signals that exceed 48 kHz

CinemaStation’s digital input jack can input a sampling frequency up to 96 kHz. For details read the owner’s manual of the device connected to the digital input jack. Keep in mind the points below when inputting a digital signal that exceeds 48 kHz.

- DSP Programs are not selectable. You can only listen to normal 2-channel stereo from the Front Speakers.
- During playback, you cannot adjust the volume level of Center and Surround L/R Speakers.
- Depending on the “* Speaker Set” setting in the SET MENU, the Subwoofer may output sound.

Switching Input Modes

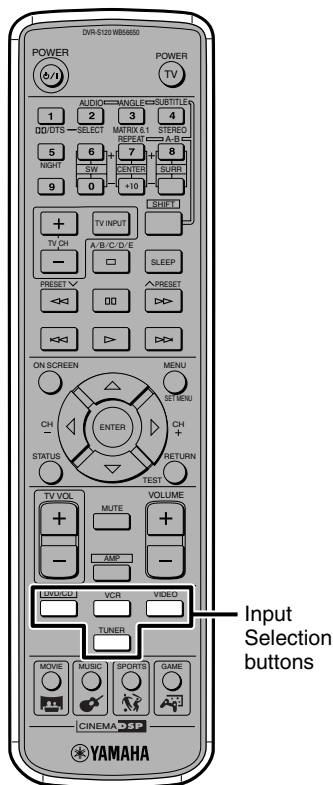

You can playback most sources without a problem with the AUTO setting (factory default setting). Then depending on your needs, you can select the priority level for digital and analog input signals, and specify formats such as DTS.

Press the Input Selection button for current input source until the desired input mode appears in the CinemaStation Display.

- AUTO:** Input signal can be selected in the order below.
- 1) Digital signal
 - 2) Analog signal
- DTS:** Only DTS can be played.
- ANLG:** Only analog signal can be played.

Learning about input modes, jacks and Input Selection buttons

CinemaStation can receive signals from the VIDEO (analog), VCR (analog) and OPTICAL (digital) jacks of equipment that is connected to it. You can assign a VIDEO or VCR input name to the OPTICAL IN jack. This will allow you to use the VIDEO button or VCR button to input a device connected to the OPTICAL IN jack (VIDEO is assigned in the default setting.) Normally, an analog signal is input to the VIDEO or VCR IN jack, and a digital signal is input to the OPTICAL IN jack. However, by setting the input mode to AUTO the input will be automatically detected and you can then playback audio from the device you want by simply pressing an Input Selection button.

Advice

- It is possible to switch Input mode even if you press INPUT on CinemaStation for more than one second.
- When Input mode is set to AUTO and a Dolby Digital or DTS signal is input, the most suitable decoder is automatically selected.
- The following happens when set to Input mode and DTS is played:
 - CinemaStation detects the DTS signal and automatically switch to DTS mode (**dts** indicator lights up). Once DTS audio finishes playback, the **dts** indicator may blink, and while it blinks only DTS audio can be played back. Immediately after DTS audio finishes playback, if you want to play normal PCM audio, reset the Input mode to AUTO.
 - If the DTS signal is interrupted when you perform Search or Skip, the **dts** indicator may blink. If this condition continues for over 30 seconds, the Input mode automatically changes from DTS to normal digital (PCM) and the **dts** goes out.
- Using “* Input Mode” in the SET MENU you can set whether to use the Input mode specified previously when CinemaStation was turned on or return to AUTO.

Note

- It is not possible to select ANLG with the DVD/CD Input Selection button.
- You cannot switch input modes when the input jack you select with the Input Selection button can only input an analog input signal.
- To play back DTS, set the Input mode to AUTO or DTS. Do not set it to ANLG. If you do, audio may not output or you may hear noise.

Using the Sleep Timer

After a specified time the power automatically enters standby so you can enjoy CinemaStation until you fall asleep.

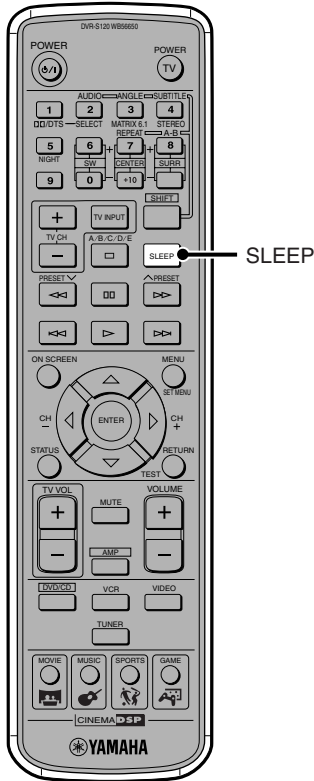

1 Play the source.

2 Repeatedly press SLEEP and set the time to enter standby mode.

The CinemaStation Display changes as shown below.

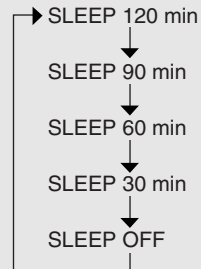

Once the Sleep Timer is set a SLEEP indicator lights up in the CinemaStation Display.

To cancel the Sleep Timer

Keep pressing SLEEP until SLEEP OFF appears in the CinemaStation Display.

In a few seconds SLEEP OFF disappears. The CinemaStation Display once again shows the DSP Program and the SLEEP indicator disappears.

Advice

- You cannot link the sleep timer of the device that is playing, so make sure to set the sleep timer of each device separately.
- The Sleep Timer cancels if you press POWER on the Remote Control, press STANDBY/ON on CinemaStation or pull out the power cord.
- Memory backup remembers the previous setting so you can use the same setting next time.

Enjoying High-Quality Video

Progressive Scan (NTSC only)

The COMPONENT VIDEO jack on CinemaStation is compatible with Progressive Scan. You can enjoy highly defined images without flicker when connecting to a television that has a component video input jack compatible with Progressive Scan.

Progressive Scan is available only for NTSC signal output. See pages 94 and 95, “On Screen Menu Guide”.

Please...

- Before connecting make sure to turn off the television and CinemaStation power.

1 Connect the television.

Use a commercially available component video cable.

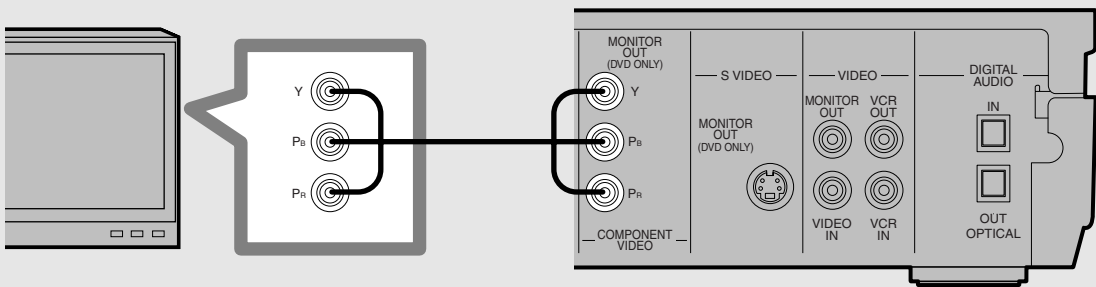

2 Start playing the DVD. See page 10, “Viewing a DVD”.

3 Press PROGRESSIVE on CinemaStation.

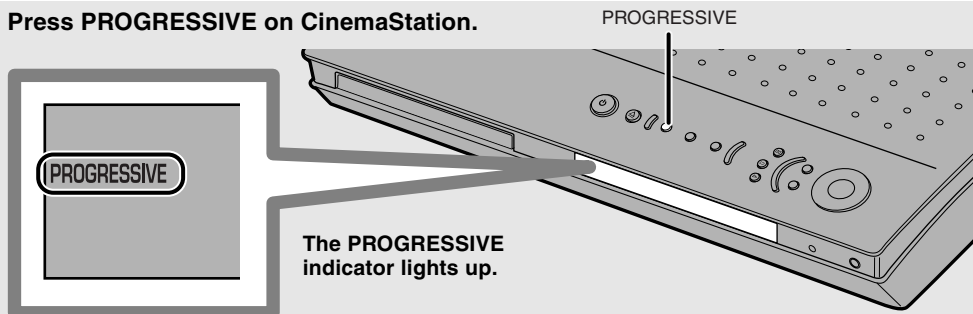

To cancel Progressive Scan

Press PROGRESSIVE to turn off the PROGRESSIVE indicator.

Advice

- If you play video with a 4:3 aspect ratio on a 16:9 wide television screen, Progressive Scan may fill the screen top to bottom. In this case, use the On Screen Menu to change to the screen display that matches your television. See pages 94 and 95, “On Screen Menu Guide”.

If you cannot adjust the size, turn off Progressive Scan. (Changes to interlace output.)

- When Progressive Scan is on, a video signal will only output from the COMPONENT VIDEO. You can use the COMPONENT VIDEO jack and Progressive Scan only for DVD playback, so it is not possible to enjoy progressive playback from other sources.

Note

CONSUMERS SHOULD NOTE THAT NOT ALL HIGH DEFINITION TELEVISION SETS ARE FULLY COMPATIBLE WITH THIS PRODUCT AND MAY CAUSE ARTIFACTS TO BE DISPLAYED IN THE PICTURE. IN CASE OF 525 PROGRESSIVE SCAN PICTURE PROBLEMS, IT IS RECOMMENDED THAT YOU SWITCH THE CONNECTION TO THE “STANDARD DEFINITION” OUTPUT. IF THERE ARE QUESTIONS REGARDING YOUR VIDEO MONITOR COMPATIBILITY WITH THIS UNIT, PLEASE CONTACT OUR CUSTOMER SERVICE CENTER.

This unit is compatible with the complete line of YAMAHA projectors, including the DPX-1, LPX-500, DPX-1000 and with the YAMAHA PDM-1 plasma display.

Protecting Your Children from Undesirable Scene Using Parental Control

You can cut a scene that you do not feel is suitable for your children, or lock a disc from being played.

CinemaStation allows you to set the level of Parental Control. It then checks the level of a disc whose level has been set in advance and automatically decides if the content is suitable for viewing by your children before playing.

Setting the Password and Parental Control Level

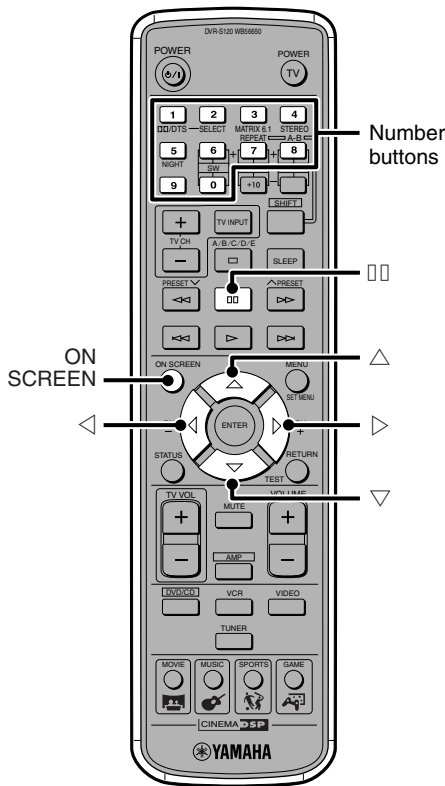

1 Press ON SCREEN.

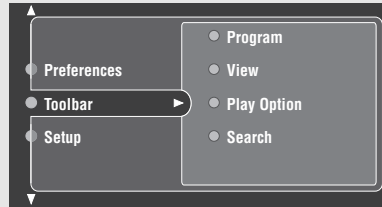

2 Press ▾ to select “Setup”.

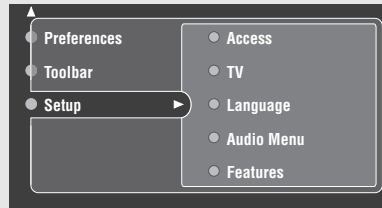

3 Press ▸ and ▲ a number of times to select “Access”.

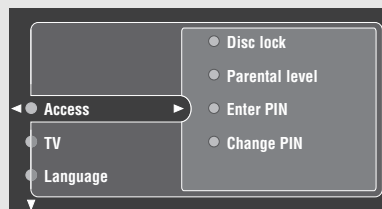

4 Press ▾ to select “Enter PIN”, then press ▸.

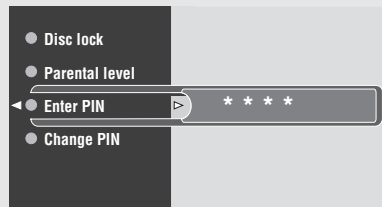

Advice

- The default password is 0000.
- If the password you input is wrong, some menu items, such as Parental level or Disc Lock, are grayed out. Enter the correct password.
- If you forget your password, press  four times, instead of the Number buttons.

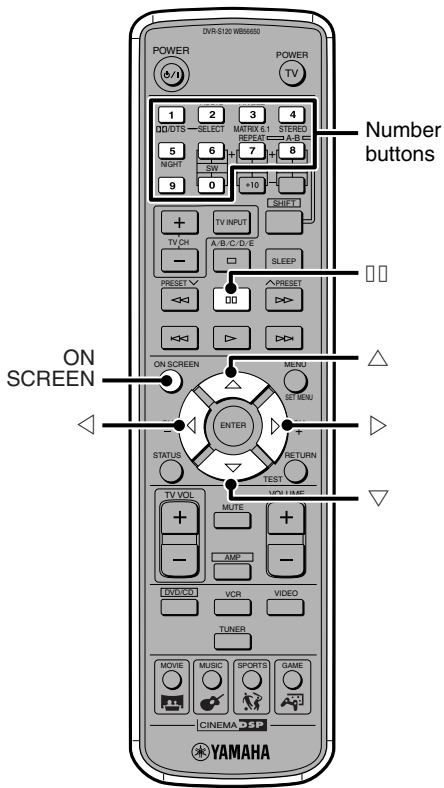

- 5** Use the Number buttons to enter a password (4 digits).



- 6** Press Δ and select "Parental level".

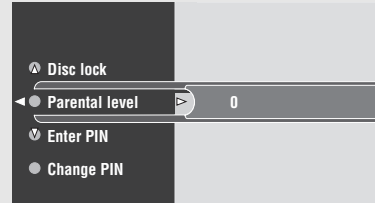

- 7** Press \triangleright or \triangleleft and select control level (0 to 8).

0: Parental Control is set to off, and you can play all discs.

1 to 7: You can play discs of same level or below the level you set. The smaller the number the stricter Parental Control is.

8: You can play all discs.

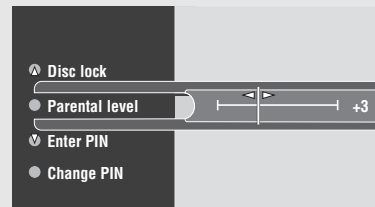

- 8** Press ON SCREEN to turn off the On Screen Menu.

Change the password

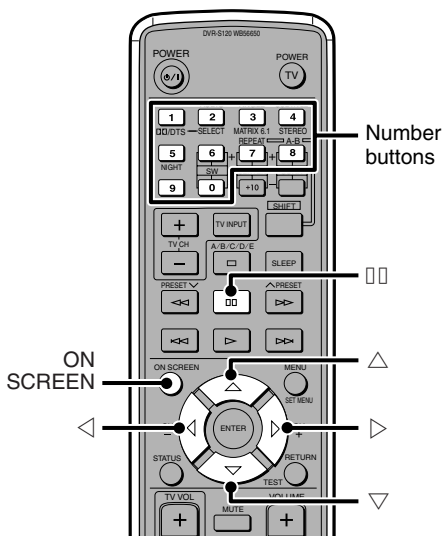

- 1** Perform steps 1 to 5 in "Setting the Password and Parental Control Level" on page 80.

- 2** Press ∇ to select Change PIN, then press \triangleright .

- 3** Enter the current password (4 digits) with the Number buttons.

- 4** Enter the new password (4 digits) with the Number buttons.

- 5** Enter the new password (4 digits) again for confirmation.

- 6** Press ON SCREEN to turn off the On Screen Menu.

Locking a Disc

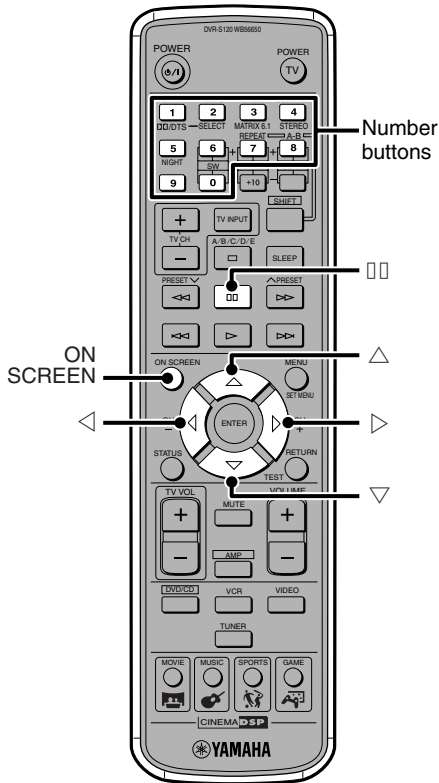

CinemaStation locks a disc by storing its ID code in memory. So the next time the disc is inserted the user is prompted to enter a password to unlock the disc. Enter the password correctly to load the disc.

- 1 Play the disc to lock.
- 2 Perform steps 1 to 5 in “Setting the Password and Parental Control Level” on page 80.

- 3 Press Δ repeatedly to select “Disc Lock”.

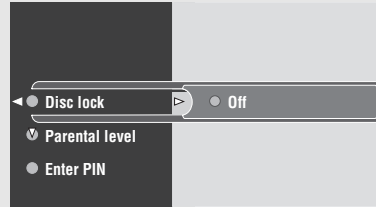

- 4 Press \triangleright to select “On”.

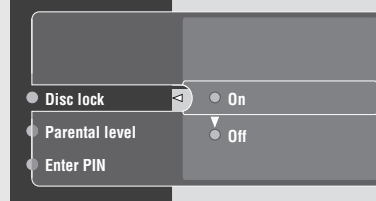

Playback is locked for that disc and disabled unless you enter the password.
Select “Off” if you do not want to lock.

- 5 Press ON SCREEN to turn off the On Screen Menu.

Advice

- If you enter a password you can play back the disc even when Disc Lock is on.
 - 1 Insert the disc.
 - 2 Select “Play once” or “Play always” with Δ or ∇ .
 - 3 Press \triangleright , then once you enter the password with the Number buttons, playback starts.
- You can set “Disc lock” to “On” for up to 120 discs.

Storing Manufacturer Codes in the Remote Control

If you set the manufacturer code (a unique code assigned to each manufacturer) in the CinemaStation Remote Control, you can operate a connected television, VCR, CD or MD recorder with the Remote Control.

Note

- Depending on the model, the Remote Control may not work, or only work with a limited number of functions. In this case, use the remote control that came with the television, VCR, CD or MD recorder.

Setting the Manufacturer Code

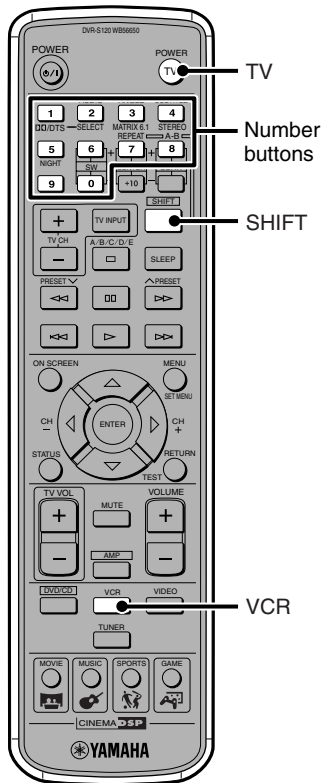

When a manufacturer code is set for the TV button or VCR button, you can begin using the features described in “Available Operations” on page 84.

Note

- For the TV button you can only set a television manufacturer code and for the VCR button you can only set a VCR, CD or MD recorder manufacturer code.

- 1 While holding down SHIFT, press TV or VCR.** Each button can be assigned one manufacturer code.

Note

- Perform steps 1 to 2 while holding down SHIFT.

- 2 While holding down SHIFT, enter the manufacturer code (3 digits) of the device with the Number buttons.**

For details, refer to “Manufacturer Code List” on pages 86 and 87.

When the setting succeeds, “Code Set OK” appears; however, when it does not, “Code Set NG” appears in the CinemaStation Display. If setting is unsuccessful, perform steps 1 and 2 again.

When finished entering the code, release your finger from SHIFT.

Advice

- The TV button has 299 and the VCR button has 399 as the factory default setting for manufacturer code.

- 3 Make sure that you set the correct manufacturer code.**

With a manufacturer code set for the TV button, press the button to turn the TV power on/off (standby), and check that the setting is working correctly.

With a manufacturer code set for the VCR button, press the button then the features described in “Available Operations” on page 84, and check that the setting is working correctly.

When the Remote Control's TV or VCR button does not work even after setting the device manufacturer code

Try again from step 1 and keep the following points in mind.

- Make sure you select the Remote Control's TV or VCR button correctly when setting the manufacturer code.
- If there are multiple manufacturer codes enter them in order.
- After reinserting batteries, try the steps again (within 2 minutes of reinserting).
(When reinserting batteries be careful not to press the Remote Control buttons. If a manufacturer code has been set for the TV or VCR button, it may get deleted.)

To return to the factory default settings

While pressing SHIFT down as in step 2 Setting the Manufacturer Code, enter 299 for TV or 399 for VCR. (Step 3 is not necessary.)

Maintaining manufacturer code settings

Replace batteries before they become unusable. When the batteries wear out and you remove them, the custom manufacturer code setting will stay in memory for about 2 minutes. Be careful because if more than 2 minutes elapse the codes may be deleted. Also, at this time, be careful not to accidentally press a Remote Control button. This can delete the codes.

Available Operations

While you set the manufacturer code for the TV or VCR button, you can use the following functions after you press the TV or VCR button.

VCR operation

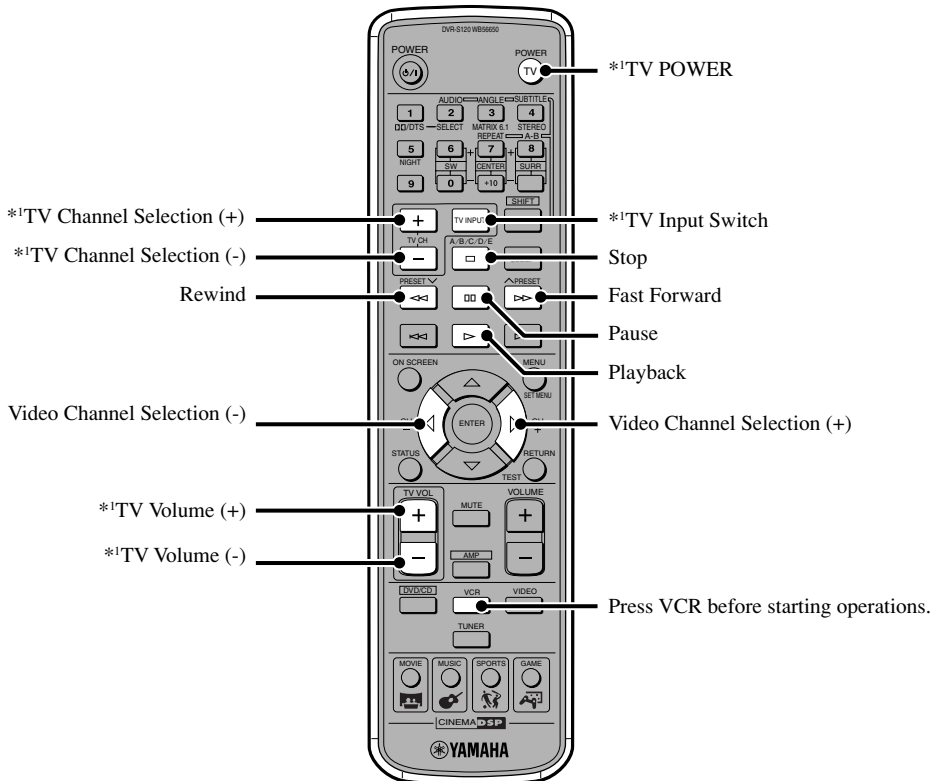

*1While you set the TV manufacturer code for the TV button, you can operate your television.

TV operation

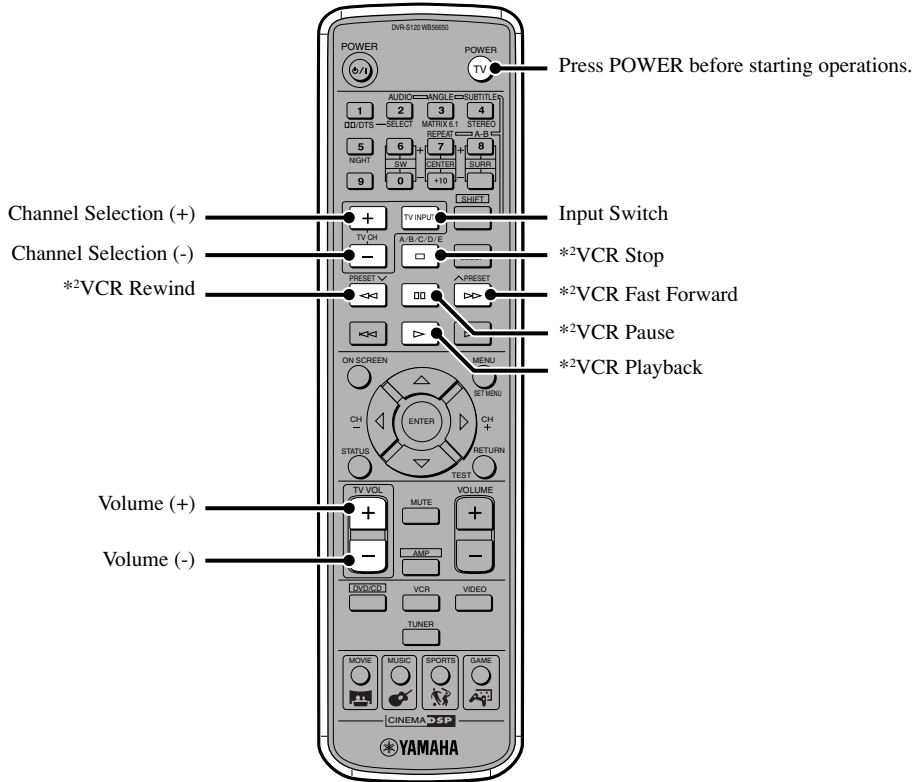

*2While you set the VCR manufacturer code for the VCR button, you can operate your VCR.

CD or MD recorder operation

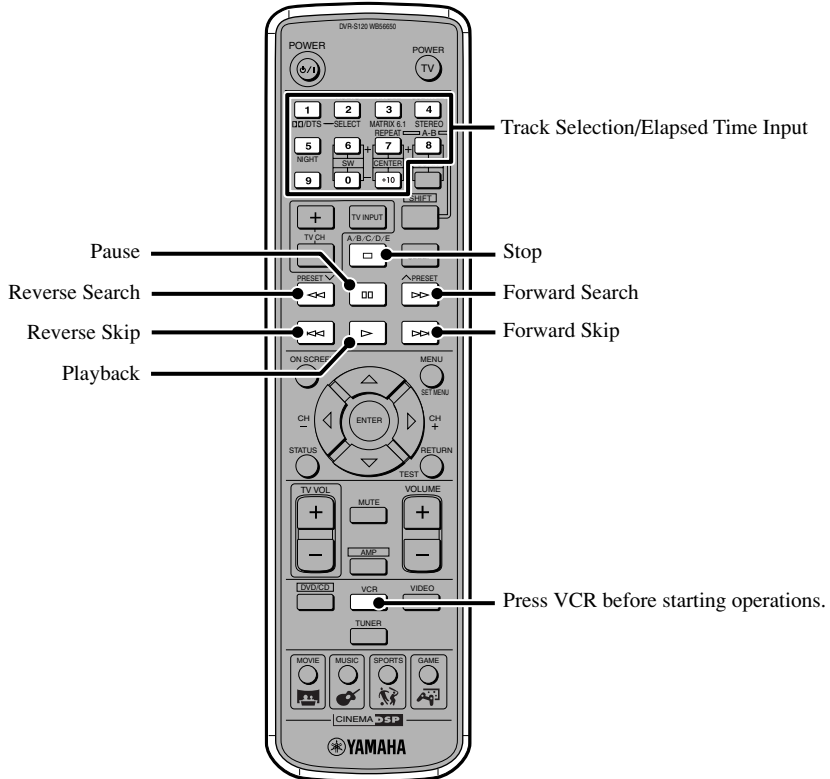

Manufacturer Code List

Depending on the model and year, you may not be able to use some manufacturer products. In this case, use the remote control supplied with each product.

TV

Manufacturer	Manufacturer Code	Manufacturer	Manufacturer Code	Manufacturer	Manufacturer Code
Yamaha	299/292	Funai	277/278/285	Portland	297/256/287
Admiral	292/293	Futuretec	285	Quasar	234/235
Aiko	287	GE	293/297/234/235/236	Radio Shack	299/293/297/285/286
Aiwa	294/276/283	Gibraltar	297	RCA	293/297/234/256/257/258
Akai	295/296	LG/Goldstar	297/298/239/237	Realistic	299/293/297/285/286
Alba	296	Goodmans	296/298/223	SABA	223/269/265/266
AOC	297/286	Grundig	229/238/249	Sampo	286/297
Audiovox	285	Harvard	285	Samsung	297/239/248/262/275/286
Belcor	297	Hitachi	297/239/242/243	Sanyo	295/233/279/272/273/274
Bell & Howell	292	ICE	296	Schneider	296
Bestar	298	Irradio	296	Scott	297/285
Blaupunkt	229/222	Itt/Nokia	244/245	Sharp	292/239/232/284
Blue sky	298	JC Penny	293/297/234/237/286	Shogun	297
Bradford	285	JVC (Victor)	296/246/247	Siemens	229
Brandt	223	Kendo	298	Signature	292
Brocsonic	297	Kenwood	297	Sony	263
Brokwood	297	KTV	297/239/285	Soundesign	285
Bush	296	Loewe	298/248	SSS	285/297
Candle	286/297	LXI	293/297/225/226/233	Starlite	285
Citizen	286/287/297	Magnavox	297/225/239/286	Sylvania	297/225/286
Clatronic	298	Marantz	286/297	Teknika	297/285/287
Contec	285	Matsui	295	Telefunken	269/264/265/266
Craig	224/285	MGA	286/297	Thomson	223/266
Croslex	225	Mitsubishi	299/297/259	Toshiba	292/226/267
Crown	285	MTC	286/297	Videch	297/242
Curtis Mathis	297/226/286	Multitec	285	Wards	297/239/232/286
CXC	285	NEC	297/252/282/286		
Daewoo	297/298/224/227/228/287	Nikko	286/287/297		
Daytron	239/297	Nokia	244/245		
Dual	298	Nokia Oceanic	245		
Dumont	297	Nordmende	265/266		
Emerson	297/224/239/232/285	NTC	287		
Envision	286/297	Onwa	296/285		
Ferguson	223/265/266	Panasonic	234/235/236/253		
First line	298	Philco	297/225/239/286		
Fisher	295/233	Philips	225		
Fraba	298	Pilot	297		
		Pioneer	226/235/254/255/268		

VCR

Manufacturer	Manufacturer Code
Yamaha	399/392/393/394
Admiral	395
Aiwa	396/397/398/329/339
Akai	322/323/324
Asha	363
Audio Dynamic	392/394
Audiovox	396
Beaumarck	363
Bell & Howell	393
Blaupunkt	325/326
Brocsonic	327
Bush	322
Calix	396
Candle	335/363/396
Canon	325/328
CGM	396/332
Citizen	396
Craig	396/363
Curtis Mathis	397/328/333/392
Cybernex	363
Daewoo	328/334/335
DBX	392/394
Dimensia	333
Dynatech	397
Electrohome	396
Electroponic	396
Emerson	327/334/396/397
Fisher	393/336
Funai	397
Garrard	397
GE	328/333/387/363
LG/Goldstar	396/388/392
Goodmans	334/337
Grandiente	397
Grundig	332/338
Hitachi	325/333/349/342/343
Harman Kardon	392
Instant Replay	325/328
Itt/Nokia	393
JCL	328
JC Penny	392/393/394/328/333/349/363/396
JVC (Victor)	392/394/344/345/346/347
Kendo	396
Kenwood	392/394/396
Kodak	396

Manufacturer	Manufacturer Code
Lloyd	397
Loewe	396/337
Luxor	395
LXI	393/396/397/336/349
Magnavox	325/326/328
Magnin	363
Marantz	392/394/328
Marta	396
Matsui	396
MEI	328
Memorex	328/336/363/396/397
Minolta	333/349/342
Mitsubishi	399/344/348/359/352/353
MTC	363/397
Multitech	397/348/354
NEC	392/394/344/383
Nikko	396
Noblex	363
Nokia	393/395
Nokia Oceanic	395
Okano	323
Olympic	325/328
Optimus	396
Orion	327
Panasonic	325/328/355/378/384/385
Pentax	333/349/342
Philco	325/328
Philips	325/326/328/337/356/357
Phonola	337
Pilot	396
Pioneer	325
Quasar	325/328
Radio Shack	396/397
Radix	396
RCA/PROSCAN	325/326/328/333/335/349/358/369/363/342
Realistic	393/397/328/336/359/362/396
Samsung	354/358/363/364/365/366/335
Sansui	394
Sanyo	393/336/367/363
Schneider	337
Scott	399/335/336/348/359/352/354/358
Sears	328/342/396
Seleco	322

Manufacturer	Manufacturer Code
Sharp	395/362/382
Siemens	393
Signature 2000	395/397
Sony	368/379/372/373/374/375
Sylvania	397/325/326/328
Symphonic	397
Tandberg	334
Tashiro	396
Tatung	392/394
Teac	392/394/397
Technics	325/328
Teknika	328/396/397
Telefunken	376/377
Thorn	393/396
Toshiba	335/369/389
Totevision	363/396
Universum	396/327/376
Vector Research	392
Videosonic	363
W.WHouse	396
Wards	395/396/336/362/328/342/363/397

CD recorder

Manufacturer	Manufacturer Code
Yamaha	499
DENON	422/423
Hitachi	424
JVC (Victor)	425/428
Kenwood	422
Marantz	422
Philips	422
Pioneer	426
Sony	427
Teac	429

MD recorder

Manufacturer	Manufacturer Code
Yamaha	599/522/598
Denon	523/524
JVC (Victor)	525
Kenwood	526
Onkyo	592
Pioneer	527
Sharp	528
Sony	522
Teac	593

Operating Other Equipment with the CinemaStation Remote Control

English

Using the SET MENU

You can use the SET MENU to adjust settings, including Speaker settings. Change the settings to match your listening environment.

SET MENU List

The SET MENU contains the items below.

Item	Default Setting (value)
* Speaker Set	
* CENTER	SML
* FRONT	SMALL
* SUR.	SML
* BASS	SWFR
* F. Level	Nrm
* LFE Level	
* SP LFE	0 dB
* HP LFE	0 dB
* SP Delay	
* CENTER	0 ms
* D. Range	
* SP D.R	MAX
* HP D.R	MAX
* L/R Balance	Center
* HP Tone CTRL	
* HP BASS	0 dB
* HP TRBL	0 dB
* Input Assign	
* OPT:	VIDEO
* Input Mode	AUTO
* Display set	
* DIMMER	0
* Tuner Step	AM9/FM50

Advice

- Even during playback you can change settings in the SET MENU.
- To learn more about “* Speaker Set” read “**Setting the Speaker Mode**” on page 62.

Navigating the SET MENU

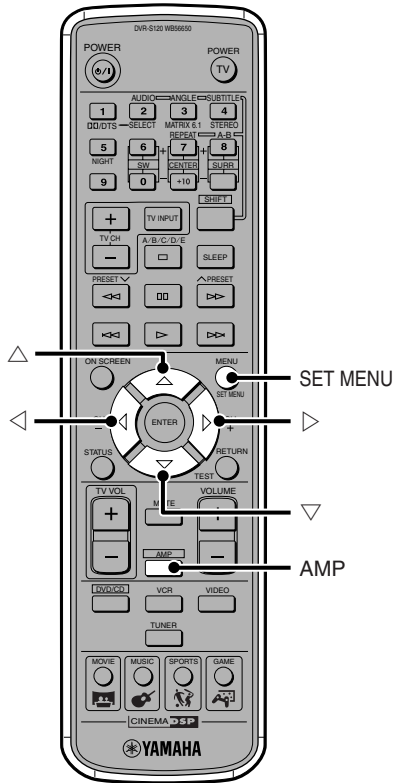

- 1** Press AMP.
- 2** Press SET MENU.
- 3** Press Δ or ∇ repeatedly to select the Menu you want.
- 4** Press \triangleleft or \triangleright .
Once in the setting mode of the selected menu the current setting appears in the CinemaStation Display. Depending on the item, press Δ or ∇ to enter a submenu.
- 5** Press \triangleleft or \triangleright repeatedly to change the setting.
- 6** When exiting the SET MENU, press SET MENU.
Pressing any one of DSP Program buttons also exits the SET MENU.

Adjust the playback level of the LFE signal (* LEF Level)

You can adjust the LFE channel output level while playing a Dolby Digital or DTS signal. Adjust the LFE level to match the performance of the Subwoofer and headphones.

Submenu: SP LFE, HP LFE

Variable range (dB): -20 to 0 dB.

Default setting: 0 dB

Set the Delay Time of the Center Speaker (* SP Delay)

You can set the Delay Time of the Center Speaker. This is effective when the Center Speaker outputs sound during Dolby Digital or DTS playback.

Normally the Center Speaker and Front L/R Speakers are placed in line with each other. However, they should be placed at an equal distance from the listener so that the sound each one outputs enters the listener's ear at the same time. With Delay Time, the Center Speaker can be moved to an ideal position further away to match the distance of each speaker to the listener. Center Delay is effective in adding depth to the sound field and presence to speech.

Variable range (ms): 0 to 5 ms

Default setting: 0 ms

Press \triangleright to set the speaker's virtual position further away. Press \triangleleft to set it closer.

Virtual Center Speaker Position

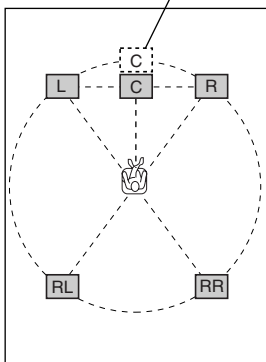

Advice

- Every 1 ms increase in Delay Time increases the distance away from the listening position by 30 cm (1 foot).

Set the dynamic range during Dolby Digital playback (* D. Range)

You can select the dynamic range (spread between the max. and min. volume) of Dolby Digital playback from 3 levels.

Submenu: SP D.R, HP D.R

Selection items: MAX (Maximum), STD (Standard), MIN (Minimum)

Default setting: MAX

MAX: Plays back the dynamic range of the source at the maximum limit.

STD: Dynamic range recommended by software manufacturers for home use.

MIN: Easy to hear even at a low volume, dynamic range suitable for evening listening.

Note

- Depending on the Dolby Digital playback source, the MIN dynamic range may not work and result in an extremely low volume. In this case, set the dynamic range to MAX or STD.

Adjust the volume balance of the Front Speakers (* L/R Balance)

You can set the volume balance of the Front L/R Speakers. This setting also applies to Headphones.

Variable range: L/R 10 levels

Default setting: Center

Press \triangleright to make the sound smaller in the Front Left Speaker, and press \triangleleft to make the sound smaller in the Front Right Speaker. You cannot turn off the sound for either one of the Front Speaker.

Adjust the sound quality of headphones (* HP Tone CTRL)

You can adjust the low tones (BASS) and high tones (TRBL) of your headphones.

Submenu: HP BASS, HP TRBL

Variable range (dB): -6 to +3 dB.

Default setting: 0 dB

Press \triangleright to increase the range of the low or high tones.

Press \triangleleft to decrease the range.

Reassign input jacks (* Input Assign)

You can assign CinemaStation's OPTICAL IN jack to VIDEO or VCR. When set to VIDEO, press the VIDEO button to operate the device connected to the OPTICAL IN jack and the input source name will appear as VIDEO. When set to VCR, press the VCR button to operate the device connected to the OPTICAL IN jack and the input source name will appear as VCR.

Selection items: VIDEO, VCR

Default setting: VIDEO

Set the input mode when powering on (* Input Mode)

Set the input mode for powering on when playback devices are connected to both digital and analog jacks.

Selection items: AUTO, LAST

Default setting: AUTO

AUTO: When CinemaStation power is turned on the input mode automatically sets to AUTO.

LAST: The last selected input mode is applied as is.

Adjust the CinemaStation Display brightness (* Display set)

Dimmer

You can adjust the CinemaStation Display brightness.

Variable range: -4 to 0

Default setting: 0

Press \triangleright to increase the brightness. Press \triangleleft to decrease the brightness.

Set frequency step (* Tuner Step) (Asia and General models only)

The inter-station frequency spacing differs depending on the areas. Set the frequency step according to the frequency spacing in your area.

Selection items: AM9/FM50, AM10/FM100

Default setting: AM9/FM50

Press \triangleright or \triangleleft to select the desired setting.

Note

- Turn off CinemaStation after you change the setting. The new setting becomes effective after you turn on CinemaStation again.
- Refer to the list below for the frequency spacing.
 - North, Central and South America: AM10/FM100
 - Other areas: AM9/FM50

Using the On Screen Menu

You can use the On Screen Menu to adjust settings for DVD playback, including picture and language settings.

Navigating the On Screen Menu

For example, adjust the color saturation.

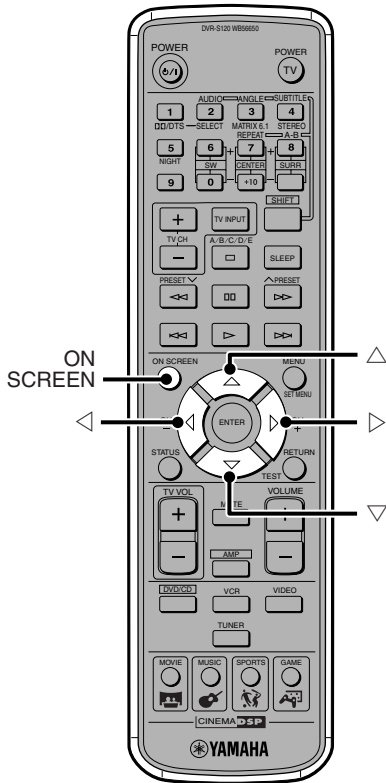

1 Press ON SCREEN.



Press \triangle or ∇ to select "Preference" in the Main Menu.

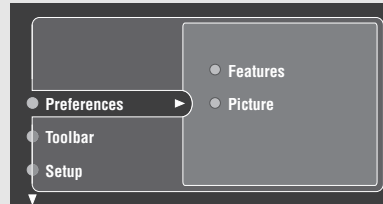

2 Press \triangleright to enter the submenus.



3 Press \triangle or ∇ to select "Picture" in the submenu.

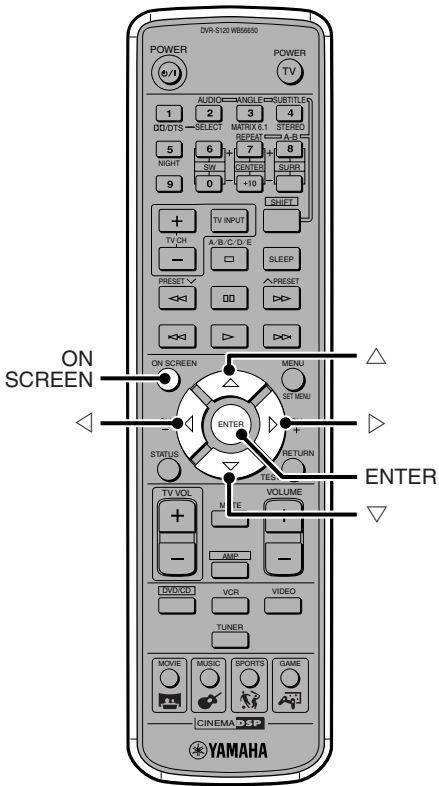

4 Press **▶** to enter menu items.



5 Press **▲** or **▼** to select "Saturation".

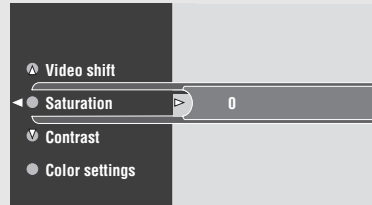

6 Press **◀** or **▶** to set.

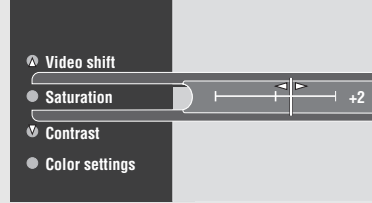

Advice

In some cases, you can also use **▲** or **▼** for setting content.

7 Press **ENTER**, then press **ON SCREEN** to turn off the On Screen Menu.

To set the other menu items, follow the example above.

On Screen Menu Guide

Main Menu	Submenu	Setting Item	Setting Content
Preference	Picture	Video shift	Adjust from +1 to +7. Adjusts the screen position.
		Saturation	Adjust from -7 to +7. Adjusts the video color saturation.
		Contrast	Adjust from -7 to +7. Accentuates bright and dark parts of video.
		Color settings (Colour settings)	Adjust the video shade.
		Brightness	Adjust from -7 to +7. Adjusts the video brightness.
		Sharpness	Adjust from -7 to +7. Adjusts the video vividness.
	Features	Status window	Set to "On" to turn on/off the status display using the STATUS button on the Remote Control. The status display includes the type of disc, the currently playing track/chapter number, the total time of track/chapter and the elapsed time of track/chapter. Set to "Off" to hide the status display.
Toolbar	Program	Clear All	Deletes all Program content. Page 33
		Tracks	Selects a track. Page 31
		Program	Selects Program Play "On"/"Off". Page 33
		Play list (Playlist)	Shows Playlist. Page 33
	View	Zoom	Enlarges the picture.
		Angle	Switches the picture angle.
		Chapter Preview	Returns to the beginning of the chapter currently playing.
	Play Option	Audio	Selects the audio language.
		Disc Navigation	Select the title, chapter or track to play.
		Sub-title (Subtitle)	Selects the subtitle language. You can only select languages the disc contains.
	Search	Frame by Frame	Advances/reverses one frame at a time. Frame Advance is not available with video CD.
		Fast	Select the speed from among -32, -8, -4, 1, 4, 8, 32.
		Time	Specify an elapsed time and search for a scene. Page 30
		Slow	Select the speed from among -1, -1/2, -1/4, -1/8, 0, 1/4, 1/2, 1.

Main Menu	Submenu	Setting Item	Setting Content
Setup	Access	Disc Lock	Set the Disc Lock "On"/"Off". Page 82
		Parental level	Adjust the level from 0 to +8. Page 81
		Enter PIN	Enter the password. Page 80
		Change PIN	Change the password. Page 81
	TV*1	TV shape	Set to match your TV screen aspect. 4:3 panscan 4:3 letterbox Wide-screen (Widescreen)
		TV System	Set the video signal system*2 to match your TV. Set to AUTO when using a TV compatible with both NTSC and PAL.
		Video Output	(U.K. and Europe models only) Sets the output signal of AV MONITOR OUT jack to YUV or RGB.
	Language	Default Sub-title (Default Subtitle)	Set the language you usually select for subtitles. When playing a disc, the subtitles in the selected language appear first. When the disc does not contain the selected subtitle language, no subtitle appear.
		Country	Select the country where you use CinemaStation.
		Menu Language	Set the language for the On Screen Menu.
		Default Audio	Set the language you usually select for audio. When playing a disc, you hear the audio in the selected language first. When the disc does not contain the selected language you selected, it will play in another language.
	Audio Menu	Digital output	Select the output signal for the OPTICAL OUT jack. The speaker sound changes depending on the setting for this menu item. All: Outputs all types of digital signals that CinemaStation can reproduce. PCM Only: Outputs the Pro Logic decoded signal only.
	Features	PBC	Set Playback Control "On"/"Off". If set to "Off", the Disc Menu does not appear on the TV screen.

*1 Be careful when setting this menu item. If it does not match your TV, the menu and playback screen will not appear properly or will not appear on the TV. If that happens, refer to "Recover TV settings" below.

*2 This unit can play PAL and NTSC, but your television must match the system used on the disc.

Recover TV settings

When the screen does not appear properly due to TV setting, perform the steps below to recover the setting.

- 1 Press DVD/CD.
- 2 Press for 5 seconds. NTSC<->PAL appears in the CinemaStation Display.
- 3 Press to switch the setting. NTSC/PAL SET appears in the CinemaStation Display.

When connecting with AV MONITOR OUT (U.K. and Europe models only)

- 1 Perform steps 1 and 2 above.
- 2 Press again. YUV<->RGB appears in the CinemaStation Display.
- 3 Press to switch the setting. YUV/RGB SET appears in the CinemaStation Display.

Solutions to Common Problems

Be sure to check the points below if CinemaStation doesn't seem to be working normally for you. If you notice something wrong that is not listed below and you have already tried some solutions with no success, turn off the CinemaStation power, remove the power plug from the outlet and contact the store where you purchased the product or your nearest YAMAHA sound products service center and ask for assistance.

General Problems

Power turns on but immediately shuts off.

Cause? 1 The power plug is not completely plugged in.

Solution! Insert the plug into the outlet firmly.

Cause? 2 Speaker cable is shorted. When power is turned on, the protective circuit engages and shuts the system down.

Solution! Make sure that all speaker cables are correctly connected.

Cause? 3 CinemaStation received a strong, external electric shock such as from a lightning bolt or excessive static electricity.

Solution! Put CinemaStation in standby, pull out the electric cord then wait for about 30 seconds before reinserting the cord and turning on the power again.

No sound.

Cause? 1 You did not connect the cable properly.

Solution! Check your connections.

Cause? 2 The source you selected is not suitable for playback.

Solution! Choose the correct source using the Input Selection buttons.

Cause? 3 You did not connect the Speaker cable properly.

Solution! Check your speaker connections.

Cause? 4 You turned the sound volume down.

Solution! Turn the sound volume up.

Cause? 5 Sound is muted.

Solution! Press MUTE or VOLUME +/- to regain the sound and adjust the volume to your liking.

Cause? 6 You inserted a CD-ROM that CinemaStation cannot play.

Solution! Play a source signal that CinemaStation can play.

No picture.

Cause? You did not connect the cable properly.

Solution! Check your connections.

The audio suddenly decreased.

Cause? The Sleep Time function started working.

Solution! Turn the power back on and try playing the source again.

Sound is too low on one side.

Cause? You did not connect the cable properly.

Solution! Check your connections.

No sound except from the Front Speakers.

Cause? 1 You are listening to STEREO sound.

Solution! Press STEREO and make sure sound field effect is on.

Cause? 2 You are playing a source such as Dolby Surround, Dolby Digital or DTS that doesn't contain a special effect signal.

Solution! Select another DSP Program.

Cause? 3 A digital audio sampling frequency over 48 kHz is input.
A digital audio sampling frequency over 48 kHz only outputs from the Front Speakers.

No sound from the Center Speaker.

Cause? 1 You turned off the Center Speaker volume level.

Solution! Turn up the Center Speaker volume. See page 60.

Cause? 2 You set “* CENTER” in the SET MENU to “NON”.

Solution! Set the Center Speaker correctly. See page 63.

Cause? 3 You have selected a DSP Program from the Music group (excluding 5ch Stereo).

Solution! Select another DSP Program. See pages 16 and 17.

Cause? 4 Dolby Digital and DTS sources do not contain a center channel signal.

Solution! —

No sound from the Surround Speakers.

Cause? 1 You turned off the Surround Speaker volume level.

Solution! Turn up the Surround Speaker volume. See page 60.

Cause? 2 CinemaStation plays a monaural source in the Theater DSP Program.

Solution! Select another DSP Program. See pages 16 and 17.

No sound from the Subwoofer.

Cause? 1 You set “* BASS” in the SET MENU to “FRONT” when CinemaStation plays a Dolby Digital or DTS source.

Solution! Set “* BASS” to “SWFR” or “BOTH”. See page 63.

Cause? 2 You set “* BASS” in the SET MENU to “FRONT” or “SWFR” when CinemaStation plays a 2-channel source.

Solution! Set “* BASS” to “BOTH”. See page 63.

Cause? 3 The source doesn't contain an LFE or other low tone signal (below 90 Hz).

Solution! —

No low tones.

Cause? The Speaker mode you selected in the SET MENU does not match your speaker.

Solution! Set the appropriate Speaker mode based on the size of the speakers you are using. See page 62.

Strange humming noises.

Cause? You did not connect the pin cable properly.

Solution! Check your pin cable connections.

Sound volume will not increase.

Cause? The power of the device connected to CinemaStation's output jack is not turned on.

Solution! If the power of the device connected to the output jack is not turned on, playback may be distorted and volume low. Turn on the power of the connected device.

Sound field effect will not work.

Cause? It is not possible to record audio enhanced by a sound field effect.

Audio recording will not work.

Cause? 1 You are trying to make a digital recording with an analog source.

Solution! Try inputting a digital source.

Cause? 2 CinemaStation and the recording device are not connected digitally.

Solution! Connect them digitally.

Cause? 3 You are trying to make an analog recording with a digital source.

Solution! Try inputting an analog source.

Cause? 4 CinemaStation, the playback device and the recording device do not share an analog connection.

Solution! Connect them with an analog connection.

Cause? 5 Some recording devices are not able to record a digital source such as Dolby Digital or DTS.

CinemaStation is not working normally.

Cause? The internal microcomputer froze up due to electric shock (lightening bolt or excessive static electricity) or drop in power supply.

Solution! Pull out the AC plug from the outlet and after about 30 seconds plug it in again.

Digital and high frequency devices create noise.

Cause? CinemaStation is placed too close to a digital or high frequency device.

Solution! Place CinemaStation further away from such devices.

SET MENU setting content has disappeared.

Cause? The power cord has not been connected to the outlet for over a week or the external timer was disconnected.

Solution! Set the SET MENU again.

Disc Playback

One of the buttons doesn't work.

Cause? Some discs do not allow certain operations.

Playback does not start when pressing ▷, or it immediately stops.

Cause? 1 When moved from a very cold place to a warm one, condensation forms on the lens.

Solution! Let it alone for 1 to 2 hours.

Cause? 2 You inserted a disc that CinemaStation cannot play.

Cause? 3 The disc is dirty.

Solution! Wipe the disc clean.

Cause? 4 The disc is not set in the tray correctly.

Solution! Set the disc in the tray correctly. See page 11.

Audio or subtitle language does not switch.

Cause? 1 The disc does not contain multiple audio or subtitle languages.

Cause? 2 Use the Disc Menu to change audio or subtitle languages. See page 36.

No subtitles appear.

Cause? 1 DVD does not contain subtitle data.

Cause? 2 The subtitle setting is off.

Solution! Turn on subtitles. See page 13.

Cause? 3 When using A-B Repeat subtitles sometimes do not appear before and after points A and B.

Viewing angle does not change.

Cause? You can only use this feature if you are playing a disc recorded with multiple angles.

VCR recording does not work.

Cause? Almost all DVD discs are copy protected, so you cannot copy them.

Picture looks poor while fast forwarding or reversing.

Cause? To some degree the picture does not look normal, but this is not a defect.

The television (monitor) has no picture. (Or the screen size looks strange.)

Cause? 1 The setting in the On Screen Menu is not correct.

Solution! Select Setup → TV in the On Screen Menu to set the menu item correctly.

Cause? 2 The television cannot handle progressive input.

Solution! Turn off CinemaStation's progressive output and change to interlace input on the television. See page 79.

Part of picture appears double with progressive output.

Cause? The disc content does not match the progressive output due to the editing method or other conditions.

Solution! Turn off CinemaStation's progressive output and change to interlace input on the television (monitor). See page 79.

The picture quality is poor.

Solution! Adjust the picture quality using "Picture" in the On Screen Menu. See page 92.

No Status display appears.

Solution! Under "Features" in the On Screen Menu, switch the "Status window" to "On". See page 92.

The disc is ejected as soon as it is inserted.

Cause? A disc that cannot be played has been inserted.

“No Disc” appears in the CinemaStation Display.

Cause? No disc is inserted or a disc is inserted incorrectly.

Solution! Set the disc in the tray correctly. See page 11.

Radio Reception**FM/AM****Preset Tuning does not work.**

Cause? 1 The Preset (memory) has been deleted.

Solution! Perform Preset again. See page 41.

FM**Too much noise blocks out stereo broadcast.**

Cause? The radio station is far away from your area or your antenna is weak.

Solution! 1 Check your antenna connection. And change your outdoor FM antenna for a multi-channel one.

Solution! 2 Try Manual Tuning. See page 40.

Audio is distorted and the receiver sensitivity is poor even with outdoor FM antenna.

Cause? You are experiencing multipath reflection and other radio interference.

Solution! Change the antenna's height, direction or placement.

Auto Tuning does not work.

Cause? The radio station is far away from your area or your antenna is weak.

Solution! 1 Try Manual Tuning. See page 40.

Solution! 2 Change your outdoor FM antenna for a multi-channel one.

AM**Auto Tuning does not work.**

Cause? The radio waves are weak or your antenna is not completely connected.

Solution! 1 Change the AM Loop antenna's direction. See page 38.

Solution! 2 Try Manual Tuning. See page 40.

Too much noise.

Cause? Noise can be related to atmospheric electricity and lightning, or fluorescent lights, motors and thermostats attached to electric devices.

Solution! Connecting the outdoor AM antenna and establishing good grounding will decrease noise. However, it is difficult to completely eliminate noise.

Too much noise, especially in the evening.

Cause? A television is in use near CinemaStation.

Solution! Place the television further away from CinemaStation.

Remote Control

The Remote Control does not work.

Cause? 1 You are outside the Remote Control operating range.

Solution! Operate the Remote Control within 6 m (20 feet) and a 30° angle of the Remote Control Sensor.

Cause? 2 The Remote Control Sensor is exposed to direct sunlight or lighting (inverted fluorescent lamps).

Solution! Change the lighting or CinemaStation's orientation.

Cause? 3 The batteries are worn out.

Solution! Replace the batteries with new ones.

Cause? 4 You did not select the device to operate.

Solution! Press the Input Selection buttons to select the device you want to operate.

Remote Control does not work with CinemaStation.

Cause? You did not select the mode to operate CinemaStation.

Solution! Press DVD/CD, AMP or TUNER on the Remote Control before starting operation.

A peripheral device does not work with the Remote Control.

Cause? 1 You cannot operate a system component.

Solution! Use the remote control that came with the device to operate it.

Cause? 2 You did not correctly set the manufacturer code.

Solution!

- Set the manufacturer code once again. See page 83.
- Set a different code from the list of codes for the same manufacturer. See page 83.

Cause? 3 The Remote Control is not compatible with your equipment.







Solution! Use the remote control that came with the device to operate it.

Information

Disc information













The table below lists the types of discs you can play on CinemaStation.

Video Discs



Type of Disc	Disc Logo Mark	
DVD Video		
SVCD (Super Video CD)		
Video CD		
		

DVD region codes

The region code (an ID number assigned to each market region) is set for normal DVD players and DVD video discs. CinemaStation can play the discs with the region codes shown below on the right. For more details read the information on the disc jacket.

Destination	Region code of CinemaStation	Playable discs	
U.S.A. Canada			
U.K. European			
Australia			
Korea General			

Music Discs

Type of Disc	Disc Logo Mark	
Music CD (Compact disc digital audio)		
		

Advice

- Disc logo marks are printed on the disc and the disc jacket.

Note

- The following discs cannot be played with this unit. CD-ROM, DVD-ROM, CDV. (This product can play some types of DVD-R, DVD-RW (Video format only), DVD+R or DVD+RW discs.)
- CinemaStation cannot play a CD-R, CD-RW, DVD-R, DVD-RW, DVD+R or DVD+RW disc that has not been finalized. Finalizing is a process that prepares a disc for playback on a compatible device.
- Only use discs from a reputable manufacturer. Some discs cannot be played back, depending on recording conditions and disc characteristics.
- Do not use discs with non-standard shapes or sizes.



- Some DVD video or video CD discs may operate and function differently than noted in this manual. That is by manufacturer design and not a defect in this unit. For more details read the information on the disc jacket.
- This unit can play the disc types associated with the logos shown on page 102. (Do not attempt to load any other type of disc into the unit, or the unit may be damaged.)
- Some discs cannot be played depending on the recording conditions such as PC environment and application software. Failure can also result from disc characteristics and condition, like material quality, scratches or curvature.

Handling a disc

- Do not touch the surface of the disc. Hold a disc by its edge and center hole.
- Do not leave a disc in the tray when you are not playing it.
- Do not write on the disc with a pencil or other marker.
- Do not stick tape, seals or other attachments to a disc, and do not bring into contact with glue.
- Do not use a protective cover to prevent scratches.
- Do not use a disc whose surface can be printed with a commercially available label printer.

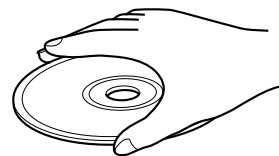

- Do not put a disc in a place with direct sunlight, high temperature, high humidity or a lot of dust.

Caution

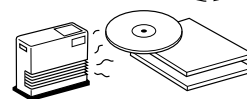

- If a disc becomes dirty, wipe it with a clean, dry cloth from the center out to the edge. Do not use record cleaner or paint thinner.

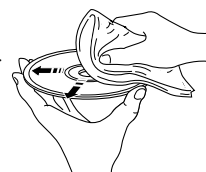

- To avoid malfunction, do not use a commercially available lens cleaner.

Copyright and logo marks

This product incorporates copyright protection technology that is protected by method claims of certain U.S. patents and other intellectual property rights owned by Macrovision Corporation and other rights owners. Use of this copyright protection technology must be authorized by Macrovision Corporation, and is intended for home and other limited viewing uses only unless otherwise authorized by Macrovision Corporation. Reverse engineering or disassembly is prohibited.

SILENT CINEMA is a trademark of YAMAHA CORPORATION.



Active Servo Processing Subwoofer System with a built-in power amplifier

This subwoofer system (NX-SW120) employs Advanced Yamaha Active Servo Technology which YAMAHA has developed for reproducing higher quality super-bass sound. This super-bass sound adds a more realistic, theater-in-the-home effect to your stereo system.



Manufactured under license from Dolby Laboratories. "Dolby", "Pro Logic", and the double-D symbol are trademarks of Dolby Laboratories.



"DTS" and "DTS Digital Surround" are registered trademarks of Digital Theater Systems, Inc.

MPEG Layer-3 audio decoding technology licensed from Fraunhofer IIS and Thomson multimedia.

Glossary

Bit Stream

A signal that is compressed and changed into digital format. Then depending on the decoder it can be processed as 5.1 multi-channel audio.

Channel (ch)

A channel is an audio type that has been divided based on range and other characteristics.

Ex. 5.1 channel

- Front Speakers, Left (1ch), Right (1ch)
 - Center Speaker (1 ch)
 - Surround Speakers, Left (1ch), Right (1ch)
 - Subwoofer (1 ch x 0.1* = 0.1 ch)
- * In contrast to a full 1-channel band, a component designed to enhance low frequency sound for added effect.

Cinema DSP (Digital Sound Field Processor)

Dolby Surround and DTS were originally designed for the movie theater, so playing the same program at home would produce disparate listening experiences depending on variables like the room size, walling and number of speakers.

Yamaha Cinema DSP applies original sound field technology based on a wealth of real-world data measurements to reproduce Dolby Pro Logic, Dolby Digital and DTS sound, combining them with acoustic scale, depth and tone so that you can experience the presence of a movie theater at home.

Component Video Signal

A component video signal is separated into one luminance Y-signal and two chrominance Pb/Cb and Pr/Cr signals. Since each signal is sent independently, color can be reproduced more faithfully. The component signal is also called a color-difference signal by the way it subtracts the luminance signal from the color signals.

Decoder

A device that converts encoded data on DVD and other media back to its original audio or video signal.

Dolby Digital

Dolby Digital is a digital surround sound system that gives you completely independent multi-channel audio. With 3 front channels (left, center, and right), and 2 surround stereo channels, Dolby Digital provides 5 full-range audio channels. With an additional channel especially for bass effects, called LFE (low frequency effect), the system has a total of 5.1 channels.

By using 2-channel stereo for the surround speakers, more accurate moving sound effects and surround sound environment can be reproduced, like the rustling of trees or sound of waves.

Dolby Pro Logic

A surround system that takes a 4-channel signal and records it as a 2-channel signal, then by way of some arithmetic processing converts back to an independent 4-channel signal for playback.

Dolby Pro Logic II

Takes any 2-channel source and reproduces dynamic 5.1-channel surround with excellent separation using special signal processing. You can experience Dolby Pro Logic II in MOVIE mode and MUSIC mode for stereo. You can even enjoy old movies that were only recorded in 2-channel audio (excluding monaural) in powerful 5.1-channel surround.

DTS (Digital Theater Systems)

The 5.1-channel surround system adopted by most movie theaters. With an abundance of audio data, it is able to provide authentic sounding effects.

Dynamic Range

The difference between the smallest sound that can be heard above the equipment noise and the biggest sound that can be heard without distortion is the dynamic range.

Film and Video Data

In general, DVD media can be classified into the 2 types below.

- Film Data
Video recorded at 24 frames/second. (The film used for shooting movies is recorded at 24 frames/second.) Recently 30 frames/second progressive video has made its debut.
- Video Data
Video recorded at 30 frames/second.

CinemaStation will automatically recognize whether the source recorded on DVD is film or video, then select the best method to convert it into progressive output.

Interlace and Progressive Outputs

Up to now the standard video signal has been NTSC with 525i (i: interlaced) scan lines. In contrast, 525p (p: progressive) is a high-density signal with double the number of scan lines.

LFE (Low Frequency Effect) 0.1 Channel

This channel is for the reproduction of low bass signals. The frequency range for this channel is 20 Hz to 120 Hz. It is added to the full-range 5 channels in Dolby Digital and DTS to enhance low frequency sound for added effect. This channel is counted as 0.1 because it only enforces a low frequency range.

Linear PCM (LPCM)

A signal that is changed to digital format without compression. A CD is recorded with 16-bit sound at 44.1kHz, while DVD recording is anywhere between 16 bits at 48 kHz to 24 bits at 192 kHz, which makes it a higher quality sound than CD. This signal also has a type called Packed PCM (P.PCM) that can be compressed without any loss of data.

Matrix 6.1

CinemaStation incorporates a Matrix 6.1 decoder for Dolby Digital and DTS multi-channel software that enables 6.1-channel reproduction by adding the surround back channel to existing 5.1-channel format. (The surround back channel is created from surround left and right channels, and output from a virtual surround back speaker.) With this additional channel, you can experience more dynamic and realistic moving sound especially scenes with "fly-over" and "fly-around" effects.

NTSC

NTSC is a video signal system (525 lines, 30 frames per second) used in North America, Central America, a number of South American countries, and some Asian countries, including Japan.

Pan & Scan and Letter Box

In general, DVD Video is produced for viewing on a wide television screen with an aspect ratio of 16:9. This means you can now view most material with the intended aspect ratio on a wide-screen television.

This ratio will not fit on a standard television that has an aspect ratio of 4:3. Two picture styles, Pan & Scan and Letterbox, deal with this problem.

- Pan & Scan cuts off the left and right portions of the picture to fill the screen.
- Letterbox inserts black bands at the top and bottom of the picture to reproduce an aspect ratio of 16:9.

PAL

PAL is a video signal system (625 lines, 25 frames per second) used in the United Kingdom, much of the rest of western Europe, several South American countries, some Middle East and Asian countries, several African countries, Australia, New Zealand, and other Pacific island countries.

Sampling Frequency and Quantized Bit Rate

When converting an analog signal to digital, the number of times the signal is sampled per second is called the sampling frequency while the degree of fineness when converting the sound level into a numeric value is called the quantized bit rate.

The frequency band that can be played back is determined by the sampling rate while the dynamic range expressing the difference in sound level is determined by the quantized bit rate. In principle, the higher the sampling rate, the wider the frequency range that can be played back. And the higher the quantized bit rate the finer the sound that can be reproduced.

SILENT CINEMA

SILENT CINEMA is an original Yamaha system that reproduces in a pair of headphones the acoustic personality of sound field programs based on multi-speakers. Headphone parameters have been set for each sound field so that natural stereoscopic sound can be expressed and enjoyed through headphones.

S-Video Signal

With S-video the video signal that was normally transmitted using a pin cable is separated and transmitted as a luminance Y-signal and chrominance C-signal through an S video cable. Connecting with an S VIDEO jack you can enjoy recording and playback with more beautiful images.

Title, Chapter (DVD Video)

DVD video lets you divide a disc in a big way by titles or a small way by chapters. Each division is either called a title number or a chapter number.

Track (CD/Video CD)

A CD or Video CD can be divided into a number of segments (tracks). Each division is called a title number.

Virtual Cinema DSP (Digital Sound Field Processor)

Reproduces a surround speaker sound field to let you enjoy virtual Center and Surround L/R Speakers with only two Front L/R Speakers.

Index

5ch Stereo 17

A

A-B Repeat 35
Action 17

C

Changing the Order of Preset Stations 43
CinemaStation Display brightness 91
Classic Hall 17
Connecting a CD or MD recorder 50
Connecting a Game Console 46
Connecting a VCR 46
Connecting the Antennas 38
Connecting the Speakers 8
Connecting the TV 8
 Connect a TV to an audio input 47
Connecting with S-video 9

D

D. Range 90
Delay Time 71
Digital audio jacks 51
Disc information 102
 Discs this unit cannot play back 103
 Handling a disc 103
 Music Discs 102
 Video Discs 102
Disc Lock 82
Disc Menu 36
Display Set 91
Dolby Digital Surround EX disc 64
Drama 17
DSP Program 17
DTS ES disc 64
DVD region codes 102

F

Fastener 53
Finding the Best DSP Effect 16
Frame Advance 29

G, H

Game 17
HP Tone CTRL 90

I, J

Input Assign 91
Input Mode 91
Input Modes 77
Jazz Club 17

L

L/R Balance 90
LEF Level 90
Live Sports 17

M, N

Matrix 6.1 64
MP3 37
Music Video 17
Night Listening 70
No Disc 100
Non-skid pad 53, 54

O, P

On Screen Menu 24
 On Screen Menu Guide 94
 Using the On Screen Menu 92
Original Dolby and DTS Sound 73
Parental Control 80
Placing the Speakers 7
Playback Control (PBC) 36
PRO LOGIC II Movie 66
PRO LOGIC II Music 66
 Pro Logic II Music setting 67
Program Play 31
Progressive Scan 79

R

Reassign input jacks 91
Recording Audio from CinemaStation 52
Remote Control 21
 Amp Mode 22
 DVD/CD Mode 23
 Tuner Mode 21
 Using the Remote Control 21
Repeat Play 34
Rock Concert 17

S

Sci-Fi (Science Fiction)	17
Selecting Radio Stations	39
Auto Tuning	39
Manual Tuning	40
Preset Tuning	43
SET MENU	90
Setting Channels in Advance (Preset)	41
Auto Preset	41
Manual Preset	42
Setting the Manufacturer Code	83
SILENT CINEMA	69
Sleep Timer	78
Slow Advance/Reverse	29
SP Delay	90
Speaker Mode	62
Speaker Size	62
Speaker Volume Level	58, 60
5ch Stereo DSP Program	61
Spectacle	17
Stereo playback	17

T

Test Tone	58
Theater	17
Time Search	30
To change discs	12
Tuner Step	91
Types of Input Signals	75

V

Virtual Cinema DSP	68
--------------------------	----

Specifications

AUDIO SECTION

Minimum RMS Output Power

FRONT L/R, CENTER, SURROUND L/R

1 kHz, 0.9% THD, 6Ω 45 W

U.S.A. and Canada models

20 Hz to 20 kHz, 0.9% THD, 6Ω 45 W

Maximum Power (EIAJ)

FRONT L/R, CENTER, SURROUND L/R

1 kHz, 10% THD, 6Ω 55 W

Total Harmonic Distortion

FRONT L/R (20 W, 1 kHz) Less than 0.05 %

Signal to Noise Ratio (IHF-A Network, shorted) 90 dB

Input Sensitivity

VIDEO, VCR 200 mV/47 kΩ

Output Level (when 200mV is input)

REC OUT 200 mV/1.2 kΩ

VIDEO SECTION

Video Signal Level

Video 1 Vp-p/75 Ω

S Video (Y/C) 1 Vp-p/0.286 Vp-p/75 Ω

Component (Y/Pb, Pr) 1 Vp-p/0.7 Vp-p/75 Ω

Signal to Noise Ratio 50 dB

TUNER SECTION

FM Tuning Range

U.S.A. and Canada models 87.5 to 107.9 MHz

Other models 87.5 to 108.0 MHz

AM Tuning Range

U.S.A., Canada and Korea models

..... 530 to 1710 kHz

U.K., Europe and Australia models

..... 531 to 1611 kHz

Asia and General models

..... 530/531 to 1710/1611 kHz

SPEAKERS

Satellite Speakers (Front and Surround Speakers)

Model Name NX-S120

Type

..... Full range acoustic suspension magnetic shielding type

Driver

... 5 cm (2 inch) full range cone x 2, magnetic shielding type

Impedance 6Ω

Center Speaker

Model Name NX-C120

Type

..... Full range acoustic suspension magnetic shielding type

Driver

... 5 cm (2 inch) full range cone x 2, magnetic shielding type

Impedance 6Ω

Subwoofer

Model Name NX-SW120

Type

..... Advanced YAMAHA Active Servo Technology system

Driver

..... 16 cm (6 1/2 inch) cone, magnetic shielding type

GENERAL

Power Supply

U.S.A. and Canada models AC 120 V/60 Hz

Australia model AC 240 V/50 Hz

U.K. and Europe models AC 230 V/50 Hz

Korea model AC 220 V/60 Hz

Asia model AC 220-240 V, 50 Hz

General model AC 110-120 V, 50 Hz

NX-SW120 for Korea, Asia and General models

..... AC 110-120/220-240 V, 50/60 Hz

Power Consumption

DVR-S120 85 W

NX-SW120 40 W

Standby Power Consumption

DVR-S120

Asia and General models 0.5 W

Other models 0.4 W

Laser Pickup

Type Semiconductor laser GaAlAs

Wave length 650 nm (DVD), 790 nm (VCD/CD)

Output Power 1.45 mW (DVD), 1.31 mW (VCD/CD)

Dimensions (W × H × D)

DVR-S120 360 × 75 × 360 mm

(14 3/16" × 2 13/16" × 14 3/16")

NX-SW120 200 × 365 × 390 mm

(7 7/8" × 14 3/8" × 15 11/32")

NX-C120 300 × 72 × 105 mm

(11 13/16" × 2 27/32" × 4 1/8")

NX-S120 72 × 170 × 108 mm

(2 27/32" × 6 11/16" × 4 1/4")

Weight

DVR-S120 6.4 kg (14 lbs 2 oz)

NX-SW120 8.4 kg (18 lbs 8 oz)

NX-C120 1.1 kg (2 lbs 6 oz)

NX-S120 0.9 kg (2 lbs)

Operating Temperature Range

..... +5 to +35°C (41 to 95°F)

Operating Humidity Range

..... 5 to 90% (No Condensation)

Accessories See page 6.

Specifications are subject to change without notice.

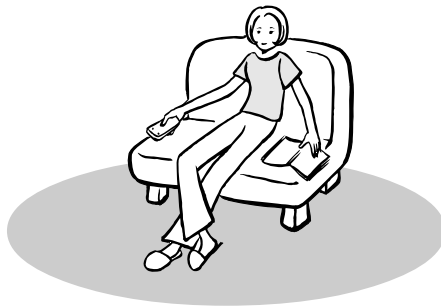

YAMAHA ELECTRONICS CORPORATION, USA 6660 ORANGETHORPE AVE., BUENA PARK, CALIF. 90620, U.S.A.
YAMAHA CANADA MUSIC LTD. 135 MILNER AVE., SCARBOROUGH, ONTARIO M1S 3R1, CANADA
YAMAHA ELECTRONIK EUROPA G.m.b.H. SIEMENSSTR. 22-34, 25462 RELLINGEN BEI HAMBURG, F.R. OF GERMANY
YAMAHA ELECTRONIQUE FRANCE S.A. RUE AMBROISE CROIZAT BP70 CROISSY-BEAUBOURG 77312 MARNE-LA-VALLÉE CEDEX02, FRANCE
YAMAHA ELECTRONICS (UK) LTD. YAMAHA HOUSE, 200 RICKMANSWORTH ROAD WATFORD, HERTS WD18 7GQ, ENGLAND
YAMAHA SCANDINAVIA A.B. J A WETTERGRENS GATA 1, BOX 30053, 400 43 VÄSTRA FRÖLUNDA, SWEDEN
YAMAHA MUSIC AUSTRALIA PTY, LTD. 17-33 MARKET ST., SOUTH MELBOURNE, 3205 VIC., AUSTRALIA

YAMAHA CORPORATION
Printed in Malaysia 🌐 WB85310-1